

## ACR Motion Controllers

88-028698-01D

# ACR Programmer's Guide

Effective: July 2010

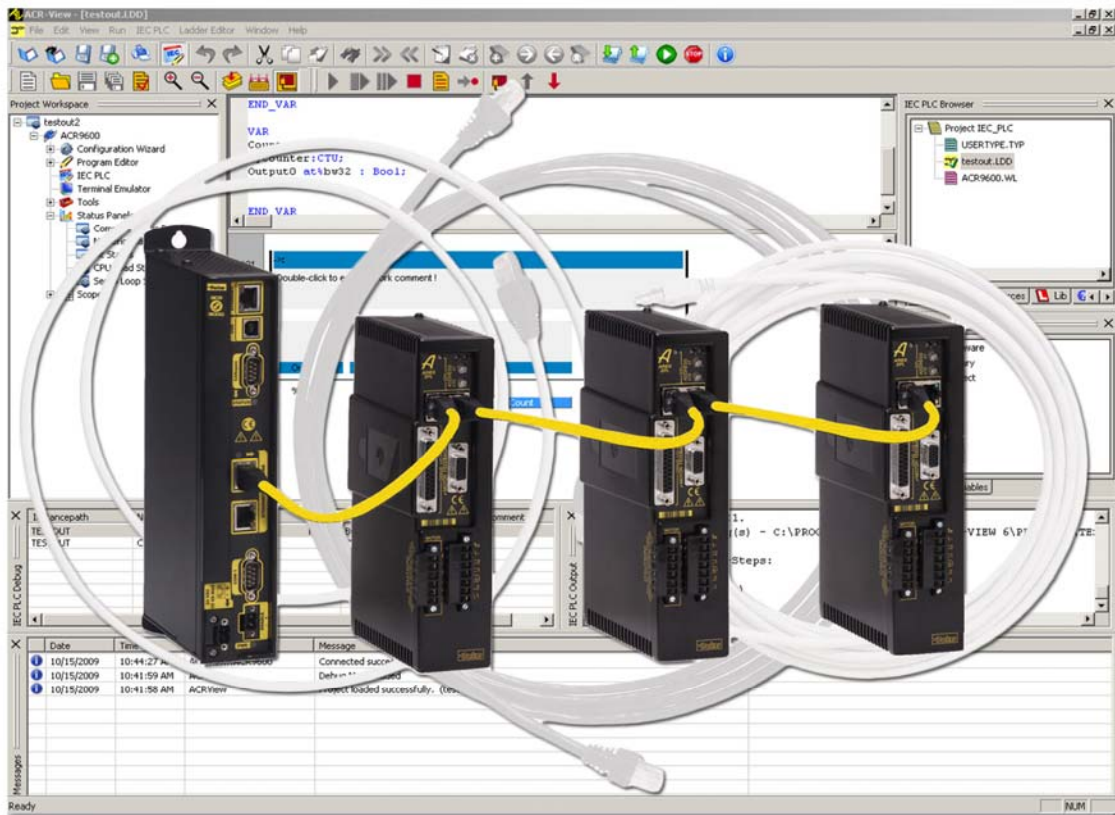

ENGINEERING YOUR SUCCESS.

# User Information



**Warning** — ACR series products are used to control electrical and mechanical components of motion control systems. You should test your motion system for safety under all potential conditions. Failure to do so can result in damage to equipment and/or serious injury to personnel.

ACR series products and the information in this guide are the proprietary property of Parker Hannifin Corporation or its licensors, and may not be copied, disclosed, or used for any purpose not expressly authorized by the owner thereof.

Since Parker Hannifin constantly strives to improve all of its products, we reserve the right to change this guide, and software and hardware mentioned therein, at any time without notice.

In no event will the provider of the equipment be liable for any incidental, consequential, or special damages of any kind or nature whatsoever, including but not limited to lost profits arising from or in any way connected with the use of the equipment or this guide.

© 2003-2007 Parker Hannifin Corporation  
All Rights Reserved

## Technical Assistance

Contact your local automation technology center (ATC) or distributor.

### North America and Asia

Parker Hannifin  
5500 Business Park Drive  
Rohnert Park, CA 94928  
Telephone: (800) 358-9070 or (707) 584-7558  
Fax: (707) 584-3793  
Email: [emn\\_support@parker.com](mailto:emn_support@parker.com)  
Internet: <http://www.parkermotion.com>

### Germany, Austria, Switzerland

Parker Hannifin  
Postfach: 77607-1720  
Robert-Bosch-Str. 22  
D-77656 Offenburg  
Telephone: +49 (0) 781 509-0  
Fax: +49 (0) 781 509-176  
Email: [sales.hauser@parker.com](mailto:sales.hauser@parker.com)  
Internet: <http://www.parker-emd.com>

### Europe (non-German speaking)

Parker Hannifin plc  
Electromechanical Automation, Europe  
Arena Business Centre  
Holy Rood Close  
Poole  
Dorset, UK  
BH17 7BA  
Telephone: +44 (0) 1202 606300  
Fax: +44 (0) 1202 606301  
Email: [support.digiplan@parker.com](mailto:support.digiplan@parker.com)  
Internet: <http://www.parker-emd.com>

### Italy

Parker Hannifin  
20092 Cinisello Balsamo  
Milan, Italy via Gounod, 1  
Telephone: +39 02 6601 2478  
Fax: +39 02 6601 2808  
Email: [sales.sbc@parker.com](mailto:sales.sbc@parker.com)  
Internet: <http://www.parker-emd.com>



Technical Support E-mail

[emn\\_support@parker.com](mailto:emn_support@parker.com)

# Table of Contents

---

<b>User Information .....</b>	<b>ii</b>
<b>Table of Contents .....</b>	<b>iii</b>
<b>Change Summary .....</b>	<b>5</b>
<b>Programming Basics .....</b>	<b>7</b>
Aliases .....	7
Program Labels .....	7
Remarks .....	8
Command Syntax .....	8
Example Code Conventions .....	11
Programs and Commands .....	12
Kill All Motion Request vs. Kill All Moves .....	14
Program Flow .....	19
Parameters and Bits .....	24
Parametric Evaluation .....	27
<b>Basic Setup .....</b>	<b>31</b>
Before You Begin .....	31
Startup Programs .....	39
Resetting the Controller .....	39
Memory .....	39
Return to Factory Default .....	40
Configuration .....	40
<b>Making Motion .....</b>	<b>48</b>
Four Basic Categories of Motion .....	48
Move Types .....	49
What are Motion Profiles? .....	53
Interaction Between Motion Profilers .....	54
Velocity Profile Commands .....	58
Coordinated Moves Profiler .....	63
Jog Profiler .....	66
Gear Profiler .....	76
Cam Profiler .....	77
Homing .....	77
<b>Servo Loop Fundamentals .....</b>	<b>87</b>
Setpoint Compensation .....	87
Following Error .....	88
<b>Application Examples .....</b>	<b>90</b>
Basic Motion .....	90
Enable Drive .....	91
EPL Network .....	92
Homing .....	93
Open Sample .....	96
Teach Array .....	97
<b>Binary Host Interface .....</b>	<b>99</b>
Binary Data Transfer .....	99
Binary Data Packets .....	101
Binary Parameter Access .....	103
Binary Peek Command .....	106
Binary Poke Command .....	107
Binary Address Command .....	108
Binary Parameter Address Command .....	110
Binary Mask Command .....	111
Binary Parameter Mask Command .....	112

Binary Move Command.....	113
Binary SET and CLR .....	120
Binary FOV Command .....	121
Binary ROV Command.....	123
Application: Binary Global Parameter Access .....	125
<b>Additional Features .....</b>	<b>127</b>
CANopen .....	127
Drive Talk .....	141
Inverse Kinematics .....	147
<b>Troubleshooting .....</b>	<b>149</b>
Problem Isolation.....	149
Information Collection .....	149
Troubleshooting Table .....	150
<b>Error Handling .....</b>	<b>158</b>
<b>Appendix .....</b>	<b>167</b>
IP Addresses, Subnets, & Subnet Masks .....	167
Output Module Software Configuration Examples .....	172
<b>Index.....</b>	<b>175</b>

# Change Summary

---

The change summary below lists the latest additions, changes, and corrections to the *ACR Programmer's Guide* and the corresponding section of ACR-View Online Help.

## Revision D Changes

Document 88-028698-01D (*ACR Programmer's Guide*) supersedes document 88-028698-01C. Changes associated with this document are notated in this section.

Topic	Description
Getting Started and System Configurations	Removed these sections.

## Revision C Changes

Document 88-028698-01C (*ACR Programmer's Guide*) supersedes document 88-028698-01B. Changes associated with this document are notated in this section.

Topic	Description
Programming Basics - <a href="#">Kill All Motion Request vs. Kill All Moves</a>	Added new section which describes and compares the Kill All Motion axis flag and the Kill All Moves master flag.
<a href="#">Application Examples</a>	Added section with sample code for a more in-depth examination of the following topics: Basic Motion, Enable Drive, Homing, Open Sample, Teach Array.
Additional Features – <a href="#">CANopen</a>	Added Example 2.

## Revision B Changes

Document 88-028698-01B (*ACR Programmer's Guide*) supersedes document 88-028698-01A. Changes associated with this document are notated in this section.

Topic	Description
Program Labels	Refined the rules.
Command Syntax	Parentheses in Arguments and Syntax section: use parentheses if a constant is signed or is changing to a variable.
Example Code Conventions	New section.

## Parker Hannifin

Startup Programs	Corrected example program.
Making Motion	Reorganized the Making Motion chapter. Added REN and RES details for Velocity Profile Commands section. Changed the term in section titles from "Commanding Motion" to "Move Types."
Jog Profiler	Added Jog Profiler section to Making Motion chapter.
Error Handling	Revised and reformatted sample error handling program.

---

# Programming Basics

---

The following section explains some fundamental concepts of the AcroBASIC programming language.

## Aliases

Alternative names, called aliases, can be assigned to parameters, bits, constants, and variables to make program code more readable. Aliases are recognized globally (across user programs).

**NOTE:** Do not confuse aliases with axis names. You can assign an axis name to an axis through the **ATTACH SLAVE** command.

Observe the following rules when creating and using aliases:

- Use a maximum of 24 letters.
- Aliases are case sensitive.
- Do not use numbers, spaces, or special characters (such as `_` and `@`).
- Use caution when using aliases with local variables.

An alias is recognized across programs, while local variables are limited to the program in which they are created. This can cause problems if you have created similar local variables in different programs. For example, if long variables are dimensioned in three programs, then the alias "counter" is assigned to LV1 (long variable 1), the controller recognizes "counter" as an alias in all three programs, though it represents a counter in only one program.

For more information, see the **#DEFINE** command in the *ACR Command Language Reference*.

- ▶ To assign aliases, use the **#DEFINE** command.

## Program Labels

Labels are program pointers which provide a method of branching to specific locations, including subroutines, within the same program. Labels can only be defined within a program and executed with a **GOTO** or **GOSUB** from within the same program.

Observe the following rules when creating and using labels:

- Precede the label with an underscore ( `_` ) character.
- Use letters (case-sensitive) and numbers, but not spaces or symbols.

- Use the **RETURN** command to indicate the end of the subroutine.
- Do not put a **REM** command on the same line as a label.

### Example

```
_START
GOSUB Label1
GOTO START
_Label1
PRINT "Inside Label1 subroutine"
RETURN
```

## Remarks

You can add comments to a program. You can put a **REM** statement by itself on a line, or you can place it on the same line after a program statement.

When following a program statement with a **REM** statement, observe the following: place a space, a colon (:), then another space between the program statement and the **REM** statement.

Comments consume memory on the controller, and can affect processing speed. By using an apostrophe (') in place of **REM**, the controller strips comments on downloading the program. Unlike **REM**, when using the apostrophe for comments, the comment must appear on its own line.

```
REM this is a comment
` this is another comment
ACC 10000 : REM this comment follows a valid program statement
```

## Command Syntax

The AcroBASIC programming language accommodates a wide range of needs by providing basic motion control building blocks, as well as sophisticated motion and program flow constructs.

The language comprises simple ASCII mnemonic commands, with each command separated by a command delimiter (carriage return, colon, or line feed). The command delimiter indicates that a command is ready for processing.

The AcroBASIC programming language uses a parent daughter approach. A parent can have daughter statements; a daughter statement is considered a sub-statement of the parent.

You can issue many parent statements alone—some provide the current status related to that particular command, others perform an action. For example, issuing the **DIM** command at the system level provides you with a report of the system dimensions. Conversely, issuing the **CLEAR** command at the system level frees the memory allocated to all programs.



You can only issue some parent commands in conjunction with a daughter statement. For example, the **FLASH** command has the **ERASE**, **LOAD**, **IMAGE**, **RES**, and **SAVE** daughter statements. Therefore, you can issue the **FLASH ERASE**, **FLASH LOAD**, **FLASH IMAGE**, **FLASH RES**, and **FLASH SAVE** commands, but not **FLASH** by itself.

## Description of Format

Each parent or daughter command shows the necessary elements to correctly use that command. The following describes how to interpret the command format presented to you in this guide:

①	<b>ACC</b>	②	<b>Set Acceleration Ramp</b>
③	<b>Format</b>		ACC { rate }
④	<b>Group</b>		Velocity Profile
⑤	<b>Units</b>		units/second2 scalable by PPU
⑥	<b>Data Type</b>		FP32
⑦	<b>Default</b>		0
⑧	<b>Prompt Level</b>		PROGx
⑨	<b>See Also</b>		<a href="#">DEC</a> , <a href="#">FVEL</a> , <a href="#">IVEL</a> , <a href="#">PPU</a> , <a href="#">STP</a> , <a href="#">VEL</a>
⑩	<b>Related Topics</b>		<a href="#">Master Parameters (0-7) (8-15)</a>
⑪	<b>Product Revision</b>		<a href="#">Command and Firmware Release</a>

1. **Mnemonic Code:** The ASCII command.
2. **Name:** A short description of the command.
3. **Format:** Indicates the proper syntax and arguments for the command.
4. **Group:** The functional group to which the command belongs.
5. **Units:** Indicates the units of measurement required by the argument(s) in the command syntax.
6. **Data Type:** Indicates the class of data required by the argument(s).
7. **Default:** Indicates the setting or value automatically selected unless you specify a substitute.
8. **Prompt Level:** Indicates the communication level at which you can use the command. For more information, see [Communication Levels](#).
9. **See Also:** Indicates commands related or similar to the command you are reviewing.
10. **Related Topics:** Indicates parameter and bit tables related to the command you are reviewing.
11. **Product Revision:** To determine whether the command applies to your specific ACR series controller and firmware revision, see the [Command and Firmware Release](#) table.

## Arguments and Syntax

The syntax of an AcroBASIC command shows you all the components necessary to use it. Commands can contain required and optional arguments. They also contain a number of symbols:

- Braces { }—arguments that are optional. Do not type the braces in your code.
- Parentheses ( )—arguments that are optional, and must appear within the parentheses in your code. Also used to indicate variables and expressions. If replacing a constant with a variable or parametric equation, use parentheses to “contain” the variable/equation. Signed (-) or (+) constants must be in parentheses.
- Commas (,)—delimiters between arguments in specific commands. In addition, select commands use commas to control spacing and line feeds. To understand the separator’s specific use in a command, refer to the command’s format and description.
- Semicolons (;)—delimiters between arguments in specific commands. In addition, select commands use semicolons to control spacing and line feeds. To understand the separator’s specific use in a command, refer to the command’s format and description.
- Slash mark (/)—signifies an incremental move in select commands.
- Quotes (“ ”)—arguments within the quotes must appear within quotes in your code.
- Number sign (#)—device arguments following number signs must include the number sign in your code.
- Ellipsis (...)—arguments can be given for multiple axes

The following examples illustrate how to interpret common syntax:

### Example 1

```
ACC {rate}
```

In the **ACC** command, the lower case word *rate* is an argument. Arguments act as placeholders for data you provide. If an argument appears in braces or parentheses, the argument is optional.

For example, the following sets the acceleration ramp to 10,000 units per second<sup>2</sup>.

```
ACC 10000
```

When you issue a command without an optional argument, the controller reports back the current setting. Not all commands report back, and some require you to specify an axis. For example, the following reports the current acceleration rate in program 0.

```
P00>ACC
10000
```

## Example 2

```
FBVEL {AXIS {value}} {AXIS {value}} ...
```

Optional arguments can nest. This provides the flexibility to set data for or receive reports on multiple axes. For example, the following sets the velocity feedback gain for axes X and Y to 0.0001 and 0.0002 respectively.

```
FBVEL X 0.0001 Y 0.0002
```

Because the **FBVEL** command can report on multiple axes, you specify at least one axis on which the controller is to report back.

```
P00>FBVEL X
0.0001
P00>FBVEL X Y
0.0001
0.0002
```

## Example 3

```
IPB {AXIS {value}} {AXIS {(value1, value2)}} ...
```

The AcroBASIC language provides programming shortcuts. You can set positive and negative values for commands using one argument. If the values differ, you can use two arguments. The command format illustrates when this is possible. For example, the following sets the in-position band for axis X to  $\pm 0.05$  and for axis y to 3 and  $-1$ .

```
IPB X 0.05 Y(3, -1)
```

Notice that the two values for axis Y are given inside parentheses and separated by a comma, as shown in the format of the command.

## Example 4

```
HALT {PROGx | PLCx | ALL}
```

The vertical bar indicates a choice between arguments. For example, the **HALT** command lets you stop a user program or PLC program or all programs.

```
HALT PROG0
HALT PLC5
HALT ALL
```

# Example Code Conventions

Examples that include code are provided throughout most of the ACR Series documentation to illustrate a concept, supply model code samples, or to show multiple ways to employ the commands.

The example code may include the terminal prompt or configuration code if it is necessary for clarity. Example code is complete only as far as conveying information about the discussion, and configuration and other information may need to be added in order for the code to be of use in an actual application.

**NOTE:** In ACR Series example code, Axis0 is the X axis, and Axis1 is the Y axis, unless otherwise specified.

## Programs and Commands

There is a subset of AcroBASIC commands that act right away. While you can use them in programs, you can also send them from a terminal emulator and effect changes immediately—commands such as **ACC**, **DEC**, and **VEL**.

You can also make on-the-fly changes to a program from a terminal emulator. At the appropriate program prompt (SYS, PROG, or PLC), you can enter the line of code. The code remains in effect until you re-download programs, cycle power to the controller, or send the **REBOOT** command; the code is not saved.

### *Immediate Mode Commands*

Immediate commands execute on pressing the ENTER key—all commands are immediate. You can use this to set operating characteristics, view the current settings, or have the controller perform the command.

- To view the current master velocity, type the **VEL** command with no value.
- To change the current master velocity, type **VEL** and then the new value such as `VEL 1000`.
- To perform a command such as turning on the first of the digital outputs type `SET 32`.

### *Adding Lines of Code to Programs*

You can add lines of code to a program that is already downloaded to the controller. This can be useful when testing or debugging an application when you do not want to make a permanent change to the program stored in ACR-View.

Each code statement you want to add must include a line number. Otherwise the controller could not understand where to place each code statement. To determine the correct line numbers, turn on line numbering through the Force Line Numbers with List bit (bit 5651). Then send the **LIST** command to display the current program.

Having determined the correct line number placement for the code statements, enter the line number, a space and the command. Such as

```
15 VEL 1000
```

The new program lines are stored in the program space.

**NOTE:** Code changes made with this procedure are not reflected in the program stored in ACR-View. To ensure your changes are permanent, enter them in the ACR-View Program Editor and download it to the controller.

## Starting, Pausing, and Halting Programs

Once downloaded to a controller, you can control programs from the SYS prompt, as well as any PROG or PLC prompt. You must include the program or PLC number when issuing the command—for example `RUN PROG0`, or `PAUSE PROG0`, or `HALT PROG0`. The following commands provide immediate program control from a terminal editor:

### Running a Program

While the program starts, the controller returns to the SYS, PROG, or PLC prompt. You can then enter immediate commands as the program runs.

- ▶ To start a program, send the **RUN** command.

### Running a Program at Power Up

You can set a specific program to automatically start after powering up or rebooting the controller,

- ▶ In the program editor, enter the **PBOOT** command as the first line in a program.

### Listening to a Program

While a program is running, you can “listen” to it. The listen mode displays data from the controller’s print statements and error messages.

- ▶ To enable the listening mode on a running program, send the **LISTEN** command.
- ▶ To exit the listening mode, press the ESC key (ASCII 27).

### Viewing a Running Program

You can also start and listen to a program using a single command. This is best used for development trouble shooting purposes. It is the only time you can view program syntax errors.

- ▶ To start a program with the listening mode enabled, send the **LRUN** command.
- ▶ To exit the listening mode, press the ESC key (ASCII 27).

### Halting a Program

You can stop motion and end program execution from the SYS, PROG, and PLC prompts using the **HALT** command.

**NOTE:** To terminate a program in the middle of execution based on a condition, use the **END** command.

- ▶ To stop a program, send the **HALT** command.

## Pausing a Program

Pausing a program places a feed hold on the current move and suspends the program at the current command line.

- ▶ To suspend a currently running program, send the **PAUSE** command.

## Resuming a Paused Program

Once paused, you can resume the program—motion and code execution continue from the places at which they paused.

- ▶ To continue program operation, send the **RESUME** command.

## Affecting Multiple Programs

You can control all programs simultaneously using the *ALL* argument. For example: **RUN ALL**, **HALT ALL**, **PAUSE ALL**, or **RESUME ALL**.

- ▶ To control all programs, use the **ALL** argument in a command.

# Kill All Motion Request vs. Kill All Moves

This section is to help clarify the difference between Kill All Motion Request and Kill All Moves.

## Kill All Motion Request (KAMR)

Kill All Motion Request (KAMR) is an *Axis Flag*. The setting of this flag (e.g., Bit Index 19 of the Quaternary Axis Flags) will stop and prevent any motion (jog, cam, gear, coordinated/master). Motion for any other axes on the same Master will also stop and be prevented until the flag is cleared.

This flag may be explicitly set by the user through the terminal, or from within an AcroBASIC program, PC program, or HMI.

This flag is automatically set any time motion is “killed” on this axis. Motion is killed when:

- End of travel limits are encountered.
- CTRL-X or CTRL-Z is issued.
- Drive fault is detected.
- Excess position error is detected.

When this flag is activated (by the user or automatically by the controller) the controller will:

- Attempt to stop the axis using the current setting for hard limit deceleration, **HLDEC**.
- Use the jog profiler to generate the setpoints necessary to bring the axis to a controlled stop. This may result in a Jog Offset. Use the **JOG RES** command to transfer the Jog Offset to

the Current (coordinated) Position register. Or home the axis to re-establish the desired zero position.

- Stop any jog, cam, gear, or ballscrew motion on the axis by clearing the flag that enable those functions on the axis.
- Set the **Kill All MOVES** flag for the Master that is assigned to that axis. This will stop and prevent any coordinated motion.
- Set the **Kill All MOTION** Request flag for any other axes on that same Master.

Any motion command issued while this flag is set will result in an error message "Associated Slave Kill Motion Request Active." This is true if any axis assigned to the same Master is commanded to move.

The user is responsible for clearing this flag.

To resume motion, first clear the Kill All Motion Request flag for the axis (and any other axes on the same Master) and then clear the Kill All Moves flag in the Master.

Enabling a drive using **DRIVE ON** command will clear the Kill All Motion Request (KAMR) and Kill All Moves flag if the drive is not currently enabled

This flag does not halt any programs or PLCs.

The KAMR flags may be cleared for all axes by issuing a CTRL-Y.

## Kill All Moves

Kill All Moves is a *Master Flag*. The setting of this flag (e.g., Bit Index 10 of the Master Flags) will stop and prevent only coordinated/master motion. Jog, cam or gear motion may continue if the Kill All Motion Request Axis Flag is not set.

This flag is set if:

- Any axis on the Master receives a Kill All Motion Request (Axis Flag). See [Kill All Motion Request \(KAMR\)](#) above.
- Stop All Moves flag is set for that Master.

This flag may be explicitly set by the user through the terminal, or from within an AcroBASIC program, PC program, or Human-Machine Interface (HMI).

Setting this flag will kill all (coordinated/master) moves without using any deceleration ramp.

This flag will not stop/kill or prevent any cam, gear, or jog motion.

This flag does not halt any programs or PLCs.

The user is responsible for clearing this flag.

The Kill All Moves flag may be cleared automatically with CTRL-Y

The Stop All Moves flag could be used in place of Kill All Moves if controlled stopping is desired. Setting the Stop All Moves flag will cause the current (coordinated) move to decelerate to zero using

the DEC setting, wait until moves have stopped, then sets the Kill All Moves flag. The Stop All Moves flag will clear after this sequence is complete and acknowledged by the processor.

### Flag Comparison

The following table shows the bit numbers for Kill All Motion Request axis flags, and the bit numbers for Kill All Moves masters flags.

Kill All Motion Request							
Quaternary Axis Flags							
Axis Number							
0	1	2	3	4	5	6	7
8467	8499	8531	8563	8595	8627	8659	8691
Axis Number							
8	9	10	11	12	13	14	15
8723	8755	8787	8819	8851	8883	8915	8947
Kill All Moves							
Master Flags							
Master Number							
0	1	2	3	4	5	6	7
522	554	586	618	650	682	714	746
Master Number							
8	9	10	11	12	13	14	15
7434	7466	7498	7530	7562	7594	7626	7658

### Bit Status Window Comparison

Locate the Bit Status Panel by clicking on the plus sign (+) next to *Status Panels* on the tree in ACR-View, and clicking on Bit Status.

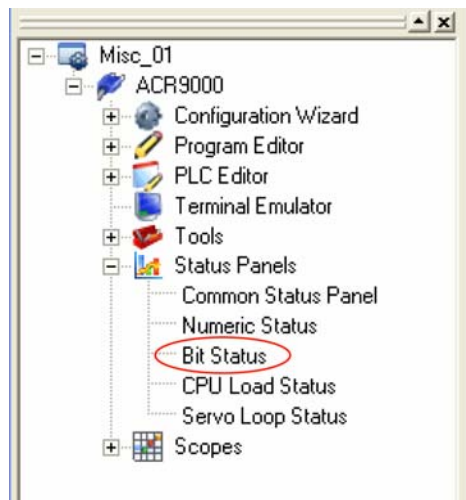



Select *Axis Flags* in the first drop-down menu, *Quaternary Axis Flags* in the second drop-down menu, and *Quaternary Axis 0 Flags* in the third drop-down menu to display the Kill All Motion Request bit for Axis 0. A green LED, as circled in red below, indicates that the flag is set. All motion is stopped for this axis and all other axes on the same master.

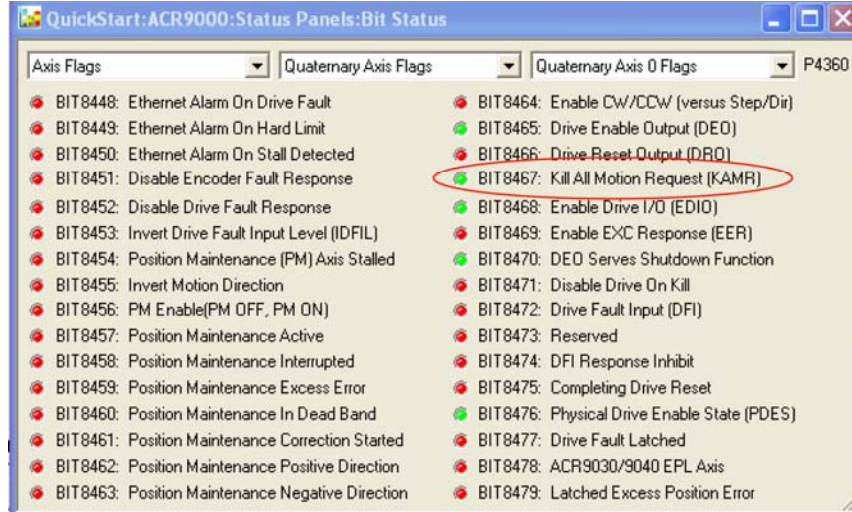

Select *Master Flags* in the first drop-down menu, *Primary Master Flags* in the second drop-down menu, and *Primary Master 0 Flags* in the third drop-down menu to display the Kill All Moves Request bit for Master 0. A green LED, as circled in red below, indicates that the flag is set.



## Example

This example uses terminal commands.

```
P00>ATTACH
ATTACH MASTER0
ATTACH SLAVE0 AXIS0 "X"
ATTACH SLAVE1 AXIS1 "Y"
REM ATTACH command will reply with information about what axes
REM are part of the Master group

P00>JOG FWD X : REM Continuous jog move on X axis
P00>SET 8467 : REM This stops motion on X axis. Axis will
REM decelerate using the HLDEC.

P00>JOG FWD Y
REM Associated Slave Kill Motion Request is active. Y-axis motion
REM is prevented due to X-axis KAMR flag.

P00>CLR 8467 CLR8499
P00>JOG FWD Y : REM Y-axis motion is now allowed.
```

**NOTE:** Enabling drives using **DRIVE ON** command will clear the Kill All Motion Request (KAMR) and Kill All Moves bits if the drive is not currently enabled.

## To Stop All Motion Immediately

Sometimes it is necessary to stop all motion immediately. You can send CTRL+X to kill motion on all axes, and terminate all program execution. While CTRL+X is similar to sending the **HALT ALL** command, CTRL+X also sets the Kill All Motion Request (KAMR) bit for each axis. When this occurs, motion is stopped at the rate set with the **HLDEC** command. Motion cannot resume until you clear the KAMR bits.

You can clear all the KAMR bits by sending the CTRL+Y command. This only clears the KAMR bits; no motion occurs.

For some applications, it may be desirable to disable the drives in addition to killing all motion. Sending CTRL+Z disables all drives in addition to the functions of CTRL+X. Disabling the drives is the same as sending the **DRIVE OFF** command.

Killing All Motion	
Command	Description
	Kills motion on all axes.
Ctrl+X	Terminates program execution. Sets the KAMR bit for each axis.
Ctrl+Y	Clears all KAMR bits.
	Kills motion on all axes.
Ctrl+Z	Terminates program execution. Sets the KAMR bit for each axis. Disables all drives.

## Program Flow

Code is executed sequentially, following the order in which it is written. But based on some input, you can shift code execution elsewhere in a program using conditional statements. Using conditional statements, you can create code that tests for specific conditions and repeats code statements.

The conditional statement provides a logical test—a truth statement—allowing decisions based on whether the conditions are met. In the code, you create an expression and test whether the result is true.

You can divide conditional statements into two sub-categories, selection and repetition.

**NOTE:** Each level (or nest) uses 4 bytes of memory. For more on memory use, see [How Much Memory?](#)

### Selection

The selection structure controls the direction of program flow. Think of it as a branch in your program. When the conditions are met, the program moves to a different block of code. AcroBASIC provides the following conditional statements:

- **IF/THEN**
- **IF/ELSE/ENDIF**
- **GOSUB**
- **GOTO**

#### IF/THEN

Programs need to run code based on specific conditions. The **IF/THEN** statement lets a program test for a specific condition and respond accordingly.

The **IF** portion sets of the condition to test; if the condition proves true, the **THEN** portion of the statement executes. If instead the condition proves false, the **THEN** statement is ignored and program execution moves on to the next statement.

**NOTE:** Enclose the condition being tested in parentheses.

Though the **IF/THEN** statement provides a single-line test, it can execute multiple statements when the condition proves true. All the statements must appear on a single line and be separated by a space, colon, and another space.

When using an **IF/THEN** statement, observe the following:

- You can nest **GOTO** and **GOSUB** statements in an **IF/THEN** statement.

### Example

The following demonstrates several simple **IF/THEN** statements.

```
IF (BIT 24) THEN P0 = P0+1
IF (P0 > 4000) THEN GOSUB 100 : P0 = P0-1
```

### IF/ELSE

The **IF/ELSE** statement provides a powerful tool for program branching and program flow control. The **IF/ELSE** statement allows you to run one set of code if the condition is true, and another set of code if the condition is false. The **IF/ELSE** statement must end with **ENDIF**.

When using an **IF/ELSE** statement, observe the following:

- You can nest **GOSUB** statements in an **IF/ELSE** statement. The **GOSUB** provides a return into the **IF/ELSE** statement.
- Do not nest **GOTO** statements in **IF/ELSE** statements. The **GOTO** statement exits the **IF/ELSE** statements, and does not provide any link back inside.
- Do not nest **IF/THEN** statements in **IF/ELSE** statements—the logic may not provide the results you expect.

**Tip:** When troubleshooting programs, use the **LIST** command to view the program stored on the controller. In recognizing **IF/ELSE** statements, the controller indents the statements under the **IF** including the **ENDIF**. If any statements in the **IF/ELSE** are not indented but should be, check the code in the program editor and re-download.

### Example

The following demonstrates different actions based on conditions being true or false. If the input (bit 24) is true, the long array increments and axis X moves an incremental 25 units. If false, the long array decrements and axis Y moves to absolute position 5.

```
IF (BIT 24)
  LA0(1) = LA0(1)+1
  X/25
ELSE
  LA0(1) = LA0(1)-1
  Y5
ENDIF
```

## ELSEIF Condition

The **IF/ELSE** statement can include the **ELSEIF** condition. The **ELSEIF** condition lets you create a series of circumstances to test. There is no practical limit to the number of **ELSEIF** conditions you can include. However, they must come before the **ELSE** condition.

Here is how it works. When the **IF** condition is true, the subsequent statements are executed. When the **IF** condition is false, each **ELSEIF** statement is tested in order. When an **ELSEIF** condition tests true, the subsequent statements are executed. When the **ELSEIF** condition test false, the statements following **ELSE** condition execute. After executing the statements following an **IF**, **ELSEIF**, or **ELSE**, the program moves past the **ENDIF** to continue program execution.

When using the **ELSEIF** condition, you can omit the **ELSE** condition. When the **IF** and **ELSEIF** conditions test false, statement execution after the **ENDIF** continues. Think of it as creating a series of **IF/THEN** statements.

## GOSUB

The **GOSUB** branches to a subroutine and returns when complete. You can use **GOSUB** and **RETURN** anywhere in a program, but both must be in the same program. A procedure can contain multiple **RETURN** statements. However, on encountering the first **RETURN** statement, the program execution branches to the statement directly following the most recently executed **GOSUB** statement.

## Example

The following example demonstrates a simple **GOSUB** routine.

```
GOSUB Label1
...
_Label1
PRINT "Inside Label1 subroutine"
RETURN
```

## GOTO

The **GOTO** statement provides an unconditional branch within a procedure. You can only use the **GOTO** in the procedure in which it appears.

You can nest **GOTO** statements in an **IF/THEN** statement.

**NOTE:** The **GOTO** statement makes code difficult to read and maintain.

## Example

The following demonstrates a simple **GOTO** statement. The program sets output bit 32, then moves axis X one incremental unit in the positive direction. The program pauses until the “Not in Position” bit 768 is clear, then clears the output, waits 2 seconds, and goes to LOOP1.

```
ACC10 DEC10 STP10 VEL1
_LOOP1
SET 32
X/1
INH -768
CLR 32
DWL 2
GOTO LOOP1
```

## Repetition

The repetition structure—known as a loop—controls the repeated execution of a statement or block of statements.

While the conditions remain true, the program loops (or iterates) through the specific code. Typically, the repetition structure includes a variable that changes with each iteration. And a test of the value determines when the conditions of the expression are satisfied. The program then moves to the next statement past the repetition structure.

If the condition is not met, the loop does not execute. In many cases that is acceptable behavior. Conversely, if the condition is always met, then the loop does not end. An endless loop is probably not a desired result, so be mindful when writing the loop conditions.

AcroBASIC also provides the following looping statements:

- **FOR/TO/STEP/NEXT**
- **WHILE/WEND**

### FOR/TO/STEP/NEXT

When you expect to loop through a block of code for a number of times, the **FOR/NEXT** loop is a good choice. It contains a counter, to which you assign starting and ending values. You also assign a **STEP** value (positive direction only), the value by which the counter increments.

When the **FOR/NEXT** loop executes the first time, the end value and the counter are compared. If the current value is past the end value, the **FOR/NEXT** loop ends and the statement immediately following executes. Otherwise, the statement block within the **FOR/NEXT** loop executes.

On each encounter of the **NEXT** statement, the counter increments and loops back to the **FOR** statement. The counter is compared to the end value with each loop. When the counter exceeds the end value, the loop skips the statement within, and proceeds to execute the statement immediately following the **FOR/NEXT** statement.

You can exit a **FOR/NEXT** loop before the counter is complete using a **BREAK** statement. When the condition is met, the statement immediately following the **FOR/NEXT** loop executes.

### Example

The following demonstrates a **FOR/NEXT** loop with a **BREAK** statement.

```
FOR LV0 = 0 TO 499 STEP 1
  PRINT LA0(LV0), SA0(LV0)
  DWL 0.01
  IF (BIT 24)
    BREAK
  ENDIF
NEXT
```

### WHILE/WEND

The **WHILE/WEND** loop executes as long as its condition remains true. You can use the **WHILE/WEND** anywhere in a program.

The **WHILE** sets the condition, and is followed by statements you want executed when the condition is true. When the condition is false, the statement immediately following **WEND** executes. The condition is evaluated only at the beginning of the loop.

When using a **WHILE/WEND** statement, observe the following:

- Do not nest **GOTO** statements in an **WHILE/WEND** statement.
- At the start of each loop through the **WHILE** condition, the validity of the condition is tested.

### Example

The following demonstrates a **WHILE/WEND** loop. While the encoder position for axis 2 is less than 1500 units, the **WHILE** statement evaluates as true. As the loop runs, the array acts as a counter, incrementing with each loop; axis X move an incremental 25 units; the program pauses for 1.5 seconds, then prints the current value of the array; and if the input (bit 24) is set the loop breaks. When the encoder count exceeds 1500, the condition is false and execution moves past the **WEND** statement.

```
WHILE (P6176 < 1500)
  LA0(1) = LA0(1) + 1
  X/25
  DWL 1.5
  PRINT LA0(1)
  IF (BIT 24)
    BREAK
  ENDIF
WEND
```

## Other Conditional Statements

There are two additional program flow control commands: **INH** and **IHPOS**. The **INH** command lets you inhibit (pause) program execution until the state of a selected bit (set or clear) occurs. Similarly, the **IHPOS** command lets you inhibit program execution until a specific axis position is occurs.

### INH

The **INH** command lets you inhibit program execution based on the set or clear state of a specified bit.

**NOTE:** Do not use **INH** in non-motion programs. If you have multiple non-motion programs, an inhibit in one non-motion program affects all non-motion programs.

### Example

The following demonstrates inhibiting a program until a certain condition is met.

```
INH 2      : REM wait until bit 2 = 1
INH -516   : REM wait until bit 516 = 0
```

### IHPOS

The **IHPOS** command lets you inhibit program execution based on the setpoint of a given parameter or a timeout is reached.

**NOTE:** While intended to inhibit program execution based on an axis position, you can use any system parameter or user defined parameter.

### Example

The following demonstrates a variety of inhibits for encoder 1.

```
IHPOS P6160 (40000,5.5) : REM wait until ENC1 >40000, or 5.5 seconds
IHPOS -P6160 (40000,5.5) : REM wait until ENC1 <40000, or 5.5 seconds
IHPOS P6160 (40000,0)   : REM wait until ENC1 >40000, no timeout
```

## Parameters and Bits

The ACR series controllers is parameter based, providing extensive control of settings and operations. The AcroBASIC language provides a simplified way to interact with the most commonly used parameters and bits. However, you can increase control and performance through direct access of the parameters and bits.

There are separate parameter and bit tables. Following each is a table providing description of the parameters or bits and the read/write attributes. The factory default state depends on the specific parameter or bit.



**NOTE:** The values for some parameters and bits change automatically through operation of the ACR controller. Changing (writing) a value does not ensure the parameter or bit retains the value over the course of operations. Use caution—forcing a value to change can cause unpredictable results.

There are two types of bits: request and non-request.

- **Request Bits:** The bit is self clearing when processed by the DSP. All request bits include “request” in the name. In most cases, there are complimentary flags that perform the opposite action. For example, the Run Request bit and the Halt Request bit control the running and halting of programs.
- **Non-Request Bits:** The bit requires clearing through a program or manually through a terminal.

Following is a list of the most commonly used parameter and bit tables:

- Master Parameters
- Master Flags
- Axis Parameters
- Axis Flags
- Object Parameters
- Program Parameters
- Program Flags

## *Using Parameters and Bits*

You can specify parameters and bits in your programs or at a terminal emulator. Use the following format:

*Px* or *BITx*, where *x* represents the parameter or bit number.

### **Example**

The following demonstrates how to format parameters and bits. Suppose your program refers to the current position for axis 0 (see table P12288-P14199 Axis Parameters), and input 24 (see table Bit0-Bit31 Opto-Isolated Inputs).

P12288  
Bit24

### **Setting Binary Bits**

You can use the **SET** command, or fix the bit value equal to 1.

## Example

The following demonstrates how to set a bit. All methods are valid.

```
SET 32
Bit32=1
SET Bit32
```

## Clearing Binary Bits

You can use the **CLR** command, or fix the bit value equal to 0.

## Example

The following demonstrates how to set a bit. All methods are valid.

```
CLR 32
Bit32=0
CLR Bit32
```

## Printing the Current Value

You can send the **PRINT** command followed by a parameter or bit whose value you want to see. Bits return the following values:

- -1 when set.
- 0 when clear.

You can use a question mark in place of the **PRINT** command. The question mark is a shortcut in a terminal emulator.

**NOTE:** When printing a system parameter, the value returned is either an integer or a 32-bit floating point.

When printing a user parameter (P0-P4095), the value returned is either an integer or 64-bit floating point.

## Example

The following demonstrates how to view values stored in parameters and bits. Parameter 6144 provides the current encoder position; Bit24 provides the current state of input 24.

```
PRINT P6144
PRINT Bit24
?P6144
?Bit24
```

## *A Word on Aliases*

Parameters and bits can use aliases. You only need to assign the alias once, and then can use it throughout user programs. The alias lets you provide a name that makes sense for programs, and makes programs easier to read.

For more information, see [Aliases](#).

## Programming Example

The following program creates a square. You can use ACR-View to set up the controller. Then enter the program into program 0 and download it to the controller.

```
RES X Y : REM reset encoder registers to 0 at startup
_LOOP
ACC 50 : REM set trajectory generator acceleration
DEC 50 : REM set trajectory generator deceleration
STP 50 : REM set trajectory generator stop ramp
VEL 5 : REM set target velocity
X5 : REM move axis to position
Y5 : REM move axis to position
X0 : REM move axis to position
Y0 : REM move axis to position
GOTO LOOP
ENDP
```

Before running the program, make sure you are at the program 0 prompt in the terminal emulator. The **LRUN** command lets you listen to through a terminal to the **PRINT** statements and error messages. This is the only way to view program errors.

- ▶ To run the program, type *LRUN*

When ready to exit the listening mode, press the `ESC` key (ASCII 27).

As the program runs, you can pause the program by setting the Feedhold Request bit or sending the **PAUSE** command. The Feedhold Request bit stops the axes using the deceleration value.

- ▶ To set the Feedhold Request bit, type *SET 520*.

You can resume the program by setting Cycle Start Request bit or sending the **RESUME** command. The Cycle Start Request bit starts the axes using the acceleration value.

- ▶ To set the Cycle Start bit, type *SET 521*.

While the program is in a feedhold, you can check the encoder position of each axis.

- ▶ To view the axis X encoder position, type *PRINT P6144*.
- ▶ To view the axis Y encoder position, type *?P6160*

## Parametric Evaluation

Most commands take arguments. Often, those command-line arguments are literals—values that are interpreted as they are written. For example, axis numbers, bit index numbers, acceleration or deceleration speeds, or positional values.

In addition to literals, you can use expressions (also called formulas). The ACR controller can solve complex integer or floating point math. To use expressions, you must enclose them in parentheses. Expressions can use the following:

- Constants
- Variables

- Parameters
- Bits
- Aliases

An expression is comprised of at least one operand and one or more operators. Operands are values, whether numerals or variables. Operators are symbols that represent specific actions. For example, the plus sign (+) represents addition, and the forward slash (/) represents division. In the expression

$$A + 7$$

A and 7 are operands, and + is an operator.

**NOTE:** For a complete list of operators available, see the Expression Reference section of the *ACR Command Language Reference*.

Operations are performed in the following order:

- Powers
- Multiplication and division
- Addition and subtraction
- Relational operations (such as greater than, less than, not equal to)

The hyperbolic (sine, cosine, tangent, etc.) and miscellaneous operators (absolute value, natural log, square root, etc.) require parentheses around their own expressions. The order of operations with such operators begins with the deepest nested parentheses.

## Parentheses

Using parentheses, you can group operations in an expression to change the order in which they are performed.

## Operational Order

For example, the expression

$$4 + 6 / 2$$

provides the answer 7, and not 5, because division performs before addition. When a mathematical expression contains operators that have the same rank, operations are performed left to right. For example, in the expression

$$2 + 6 / 3 * 5 - 9$$

division and multiplication perform before addition and subtraction. The first operation is  $6 / 3$ ; the second operation multiplies the result 2 by 5, which results as 10. In the third operation, add 2 to 10, which results as 12. In the fourth operation, subtract 9 from 12 to produce the final answer of 3.

By using parentheses, you can change the order of operations in an expression. That is, operations in parentheses are performed first, then operations outside the parentheses. For example, the expression

$$(2 + 6 / 3) * 5 - 9$$

results in an answer of 11, while the expression

$$(2 + 6 / 3) * (5 - 9)$$

results in -16 as the answer.

## Nested Parentheses

You can also embed parentheses, where operations in the deepest parentheses are performed first. For example, the expression

$$((7 + 3) / 2) * 3$$

contains embedded parentheses. From the example, the first operation is 7+3, the second operation is 10/2, and the third operation is 5\*3, which results in 15 as the answer.

## Examples

The following demonstrate some simple uses of expressions. The examples assume memory space is allocated for the variables.

### Example 1

The following causes axis X to move position to the resulting value of the expression.

```
X(P0 + P2 * P30)
```

### Example 2

When the following IF statement proves true, the message "OK" prints.

```
IF(P0=1234) THEN PRINT "ok"
```

### Example 3

The following concatenates strings \$V1 and \$V2, and sets string \$V0 equal to the result.

```
$V0 = $V1 + $V2
```

### Example 4

The following program generates a random number from 0 to 999. As the program loops, it counts each loop. When the number equals 123, the program exits the loop and prints the count.

```
PROGRAM
DIM LV(2) : REM dimension 2 long variables
LV0=0 : REM set LV0 equal to 0
_LOOP1
LV1=RND(1000) : REM set LV1 equal to random number
LV0=LV0+1 : REM increment LV0 with each loop
IF (LV1<>123) THEN GOTO LOOP1
PRINT "Done in";lv0;"tries"
ENDP
```

### Example 5

The following flashes the first 30 outputs in a random sequence.

```
PROGRAM  
  
DIM DV(1) : REM dimension 1 floating point variable  
_LOOP2  
DV0=RND(4294967295) : REM set DV0 equal to random number  
P4097= DV0 : REM set onboard outputs equal to DV0  
GOTO LOOP2  
  
ENDP
```

# Basic Setup

---

## Before You Begin

The tables in this section list commands according to the following command groups:

[Axis Limits](#)

[Character I/O](#)

[Drive Control](#)

[Feedback Control](#)

[Global Objects](#)

[Interpolation](#)

[Logic Function](#)

[Memory Control](#)

[Non-Volatile](#)

[Operating System](#)

[Program Control](#)

[Program Flow](#)

[Servo Control](#)

[Setpoint Control](#)

[Transformation](#)

[Velocity Profile](#)



**Warning** — ACR Series products are used to control electrical and mechanical components of motion control systems. You should test your motion system for safety under all potential conditions. Failure to do so can result in damage to equipment and/or serious injury to personnel.

## Axis Limits

Command	Description
<b>ALM</b>	Set stroke limit 'A'
<b>BLM</b>	Set stroke limit 'B'
<b>EXC</b>	Set excess error band
<b>HLBIT</b>	Set hardware limit/homing input
<b>HLDEC</b>	Hardware limit deceleration
<b>HLIM</b>	Hardware limit enable
<b>IPB</b>	Set in-position band
<b>ITB</b>	Set in-torque band
<b>JLM</b>	Set jog limits
<b>MAXVEL</b>	Set velocity limits
<b>PM</b>	Position maintenance
<b>SLDEC</b>	Software limit deceleration
<b>SLIM</b>	Software limit enable
<b>SLM</b>	Software positive/negative travel range
<b>TLM</b>	Set torque limits

## Character I/O

Command	Description
<b>CLOSE</b>	Close a device
<b>DTALK</b>	Drive talk
<b>INPUT</b>	Receive data from a device
<b>OPEN</b>	Open a device
<b>PRINT</b>	Send data to a device
<b>TALK TO</b>	Talk to device

## Drive Control

Command	Description
<b>DRIVE</b>	Drive report-back
<b>EPLC</b>	Define EPLC



## Feedback Control

Command	Description
<b>HSINT</b>	High speed interrupt
<b>INTCAP</b>	Encoder capture
<b>MSEEK</b>	Marker seek operation
<b>MULT</b>	Set encoder multipliers
<b>NORM</b>	Normalize current position
<b>OOP</b>	High speed output
<b>PPU</b>	Set axis pulse/unit ratio
<b>REN</b>	Match position with encoder
<b>RES</b>	Reset or preload encoder
<b>ROTARY</b>	Set rotary axis length

## Global Objects

Command	Description
<b>ADC</b>	Analog input control
<b>ADCX</b>	Expansion board analog input
<b>AXIS</b>	Direct axis access
<b>CIP</b>	Ethernet/IP status
<b>DAC</b>	Analog output control
<b>ENC</b>	Quadrature input control
<b>FSTAT</b>	Fast status setup
<b>LIMIT</b>	Frequency limiter
<b>MASTER</b>	Direct master access
<b>PLS</b>	Programmable limit switch
<b>RATCH</b>	Software ratchet
<b>SAMP</b>	Data sampling control

## *Interpolation*

Command	Description
<b>CIRCCW</b>	Counter clockwise circular move
<b>CIRCW</b>	Clockwise circular move
<b>INT</b>	Interruptible move
<b>INVK</b>	Inverse kinematics
<b>MOV</b>	Define a linear move
<b>NURB</b>	NURBs interpolation mode
<b>SINE</b>	Sinusoidal move
<b>SPLINE</b>	Spline interpolation mode
<b>TANG</b>	Tangential move mode
<b>TARC</b>	3-D circular interpolation
<b>TRJ</b>	Start new trajectory

## *Logic Function*

Command	Description
<b>CLR</b>	Clear a bit flag
<b>DWL</b>	Delay for a given period
<b>IHPOS</b>	Inhibit on position
<b>INH</b>	Inhibit on bit high or low
<b>MASK</b>	Safe bit masking
<b>SET</b>	Set a bit flag
<b>TRG</b>	Start move on trigger

## *Memory Control*

Command	Description
<b>CLEAR</b>	Clear memory allocation
<b>DIM</b>	Allocate memory
<b>MEM</b>	Display memory allocation

## Non-Volatile

Command	Description
<b>BRESET</b>	Disable battery backup
<b>ELOAD</b>	Load system parameters
<b>ERASE</b>	Clear the EEPROM
<b>ESAVE</b>	Save system parameters
<b>FIRMWARE</b>	Firmware upgrade/backup
<b>FLASH</b>	Create user image in flash
<b>PBOOT</b>	Auto-run program
<b>PROM</b>	Dump burner image

## Operating System

Command	Description
<b>ATTACH</b>	Define attachments
<b>CONFIG</b>	Hardware configuration
<b>CPU</b>	Display processor loading
<b>DEF</b>	Display the defined variable
<b>#DEFINE</b>	Define variable
<b>DETACH</b>	Clear attachments
<b>DIAG</b>	Display system diagnostics
<b>ECHO</b>	Character echo control
<b>HELP</b>	Display command list
<b>IP</b>	IP address
<b>MODE</b>	Binary data formatting
<b>PASSWORD</b>	Block uploading programs from board
<b>PERIOD</b>	Set base system timer period
<b>PLC</b>	Switch to a PLC prompt
<b>PROG</b>	Switch to a program prompt
<b>REBOOT</b>	Reboot controller card
<b>STREAM</b>	Display stream name
<b>SYS</b>	Return to system prompt
<b>VER</b>	Display firmware version

## Program Control

Command	Description
<b>AUT</b>	Turn off block mode
<b>BLK</b>	Turn on block mode
<b>HALT</b>	Halt an executing program
<b>LIST</b>	List a stored program
<b>LISTEN</b>	Listen to program output
<b>LRUN</b>	Run and listen to a program
<b>NEW</b>	Clear out a stored program
<b>PAUSE</b>	Activate pause mode
<b>REM</b>	Program comment
<b>RESUME</b>	Release pause mode
<b>RUN</b>	Run a stored program
<b>STEP</b>	Step in block mode
<b>TROFF</b>	Turn off trace mode
<b>TRON</b>	Turn on trace mode

## Program Flow

Command	Description
<b>BREAK</b>	Exit a program loop
<b>END</b>	End of program execution
<b>ENDP</b>	End program without line numbers
<b>FOR / TO / STEP / NEXT</b>	Relative program path shift
<b>GOSUB</b>	Branch to a subroutine
<b>GOTO</b>	Branch to a new line number
<b>IF/ELSE IF/ELSE/ENDIF</b>	Conditional execution
<b>IF / THEN</b>	Conditional execution
<b>PROGRAM</b>	Beginning of program definition
<b>RETURN</b>	Return from a subroutine
<b>WHILE/WEND</b>	Loop execution conditional

## Servo Control

Command	Description
<b>DGAIN</b>	Set derivative gain
<b>DIN</b>	Dead zone integrator negative value
<b>DIP</b>	Dead zone integrator positive value
<b>DWIDTH</b>	Set derivative sample period
<b>DZL</b>	Dead zone inner band
<b>DZU</b>	Dead zone outer band
<b>FBVEL</b>	Set feedback velocity
<b>FFACC</b>	Set feedforward acceleration
<b>FFVC</b>	Feedforward velocity cutoff region
<b>FFVEL</b>	Set feedforward velocity
<b>FLT</b>	Digital filter move
<b>IDELAY</b>	Set integral time-out delay
<b>IGAIN</b>	Set integral gain
<b>ILIMIT</b>	Set integral anti-windup limit
<b>KVF</b>	PV loop feedforward gain
<b>KVI</b>	PV loop integral gain
<b>KVP</b>	PV loop proportional gain
<b>LOPASS</b>	Setup lopass filter
<b>NOTCH</b>	Setup notch filter
<b>PGAIN</b>	Set proportional gain

## Setpoint Control

Command	Description
<b>BKL</b>	Set backlash compensation
<b>BSC</b>	Ballscrew compensation
<b>CAM</b>	Electronic cam
<b>GEAR</b>	Electronic gearing
<b>HDW</b>	Hand wheel
<b>JOG</b>	Single axis velocity profile
<b>LOCK</b>	Lock gantry axis
<b>UNLOCK</b>	Unlock gantry axis

## Transformation

Command	Description
<b>FLZ</b>	Relative program path shift
<b>OFFSET</b>	Absolute program path shift
<b>ROTATE</b>	Rotate a programmed path
<b>SCALE</b>	Scale a programmed path

## Velocity Profile

Command	Description
<b>ACC</b>	Set acceleration ramp
<b>DEC</b>	Set deceleration ramp
<b>F</b>	Set velocity in units/minute
<b>FOV</b>	Set feedrate override
<b>FVEL</b>	Set final velocity
<b>IVEL</b>	Set initial velocity
<b>JRK</b>	Set jerk parameter (S-curve)
<b>LOOK</b>	Lookahead mode
<b>MBUF</b>	Multiple move buffer mode
<b>ROV</b>	Set rapid feedrate override
<b>SRC</b>	Set external time base
<b>STP</b>	Set stop ramp
<b>SYNC</b>	Synchronization mode
<b>TMOV</b>	Set time based move
<b>TOV</b>	Time override
<b>VECDEF</b>	Define automatic vector
<b>VECTOR</b>	Set manual vector
<b>VEL</b>	Set target velocity for a move

## Startup Programs

You can set a program to automatically run on powering up or rebooting the controller. The **PBOOT** command provides that ability.

- The **PBOOT** command must appear as the first statement in a program.
- From a terminal, sending the **PBOOT** command starts all PBOOT programs.
- Every PROG and PLC can use PBOOT.

### Example

The following program runs on power-up, flashing output 32.

```
PROGRAM
PBOOT : REM PBOOT must appear as first line
REM Beginning of loop
  LOOP1
  BIT 32 = NOT BIT 32
  DWL 0.25
  GOTO LOOP1
ENDP
```

## Resetting the Controller

When you reset the controller, it shuts down communications, turns off outputs, and kills all programs. For controllers with non-volatile memory, the controller stores all conditions.

There are several ways to reset the ACR series controller:

- Cycle power.
- Send the **REBOOT** command.

## Memory

Memory allocation is completely customizable on the ACR series controllers. The **DIM** commands allocate memory to program and PLC spaces, global and local variables, communication streams, and aliases.

Once you have allocated memory, you cannot change it without first clearing the memory space. Otherwise, you receive a "Re-dimensioned block" error.

For information about memory allocation, see [Memory Allocations](#).

## Return to Factory Default

Various commands can return specific sections of the ACR controller to factory default. To reset the entire ACR controller, you must issue certain commands in a specific order.

1. Open ACR-View
2. Connect to the controller.
3. Open a Terminal Editor.
4. At the system prompt, enter the following commands in order:

```
HALT ALL
```

```
NEW ALL
```

```
DETACH ALL
```

```
CLEAR
```

```
ERASE
```

```
FLASH ERASE (omit for ACR8000)
```

```
CONFIG CLEAR
```

```
CLEAR DPCB (use only with ACR1505 and ACR8020)
```

```
CLEAR FIFO (omit for ACR9000)
```

```
CLEAR COM1
```

```
CLEAR COM2
```

```
BRESET
```

```
REBOOT
```

## Configuration

Because the ACR series controller is powerful and flexible, it requires configuration for your particular application. There are two methods: you can manually write the configuration code, or use the Configuration Wizard in the ACR-View software.

As the number of axes increase, the code required to configure a controller can be extensive. The Configuration Wizard helps ensure all constituent devices are configured quickly and correctly.

The configuration code for different models of ACR series controllers varies—dependant on each model's distinct feature set and options, as well as various drives, motors and encoders connected to it. In addition, the firmware revision you have for a controller can affect which features and AcroBASIC commands are available to you.



The wizard makes some choices for you behind the scenes. The ACR9000 has the largest feature set, and typically requires configuration for those features. The ACR1505 and ACR8020 may require different configuration.

The Configuration Wizard, once completed, lets you review the code it has generated. In that configuration code, you might find code for features that do not apply to your specific controller. For example, for an ACR9000 the wizard generates code for CANopen defaults, though your particular controller may not have the CANopen option. This does not impair the controller or its performance.

**NOTE:** The wizard does not collect data in the same order in which code is written.

### *A Note on the Jog/Home/Limits Dialog*

In the Configuration Wizard, the Jog/Home/Limits dialog lets you test and commission a specific axis. You can set a motion profile to exercise the axis, allowing you to test its performance when jogging or homing.

The Jog/Home/Limits dialog is only for testing, and does not write any jogging or homing code.

### *What is Configuration Code?*

To get a sense of what configuration code looks like—the requirements and order of items, as well as information that goes into the program space—the following example looks at the code resulting from the Getting Started-Tutorial.

**NOTE:** The application is controlled by a 4-axis ACR9000 (Stand Alone with COM port, Ethernet, USB, standard memory—no battery backup—, and no daughter card).

### **The Code**

The wizard generates the Primary System Settings automatically, and does not collect data for this. If you are writing your own configuration code, it is good coding practice to include the following at the beginning. The controller is switched to the SYS prompt. From there, all program execution is halted (**HALT ALL**), all user programs and PLC programs are deleted (**NEW ALL**), all memory allocations are cleared (**CLEAR**), and all slaves are detached from their respective masters (**DETACH ALL**).

```
REM -- Primary System Settings for ACR Device
SYS
HALT ALL
NEW ALL
CLEAR
DETACH ALL
```

If you do not make any changes to the Memory defaults, the wizard allocates additional memory to programs zero and one. In addition, the wizard allocates memory to program 15, which stores wizard data.

```

REM-----Allocate system memory-----
DIM PROG0(8192)
DIM PROG1(4096)
DIM PROG2(1000)
DIM PROG3(1000)
DIM PROG4(1000)
DIM PROG5(1000)
DIM PROG6(1000)
DIM PROG7(1000)
DIM PROG8(1000)
DIM PROG9(1000)
DIM PROG10(1000)
DIM PROG11(1000)
DIM PROG12(1000)
DIM PROG13(1000)
DIM PROG14(1000)
DIM PROG15(28672)
REM Some Global Memory is used by Wizard Generated Code
REM P0000 - P0099 Available for User programs
REM P0100 - P0200 Reserved for Software Limits Code
REM P0201 - P4095 Available for User programs
DIM P(100)
DIM DEF(20)

```

The Configuration Wizard, again, generates default configuration information. The wizard explicitly sets the ADC mode—the ACR9000 is a 16-bit card and cannot operate otherwise. The next section is specific to the ACR9000 and does not apply to other ACR Controllers. Though the controller in this example does not have CANopen, the wizard generates the set up for CANopen.

When writing your own configuration files, the **ADC MODE** statement is not required for the ACR9000. Likewise, if the controller does not have the CANopen feature, the CANopen setup is not required.

```

REM -- Hardware Configuration

REM 0 = 12 bit card present, 1 = 16 bit card present
ADC MODE 1

REM CANopen Settings
P32768=5
P32769=125
P32772=50
P32770=0

```

Then begins axis-specific configuration. The axis feedback and signal output information comes from the Axis and Feedback dialogs. The PPU (pulses per programming unit) is computed from data provided through the Feedback and Scaling dialogs. The excess error band data comes from the Fault dialogs.

```

ATTACH AXIS0 ENCO DAC0 ENCO
AXIS0 PPU 39999.999404
AXIS0 EXC (0.2,-0.2)

```

The next section is specific to the ACR9000 and currently does not apply to other ACR controllers. The Extended I/O section sets and clears bits related to homing, hardware and software limits, and drive faults—all performed behind the scenes and does not come from user supplied data.

```
REM ACR Extended IO Settings
SET BIT8468
CLR BIT8464
CLR BIT8470
SET BIT8469
CLR BIT8453
CLR BIT8471
ENC0 SRC 0
ENC0 MULT 4
```

The next section is specific to the ACR9000 and does not apply to other ACR controllers. From the Servo Gains dialog, the gain values are fixed.

```
REM Axis Gains values
AXIS0 PGAIN 0.002441
AXIS0 IGAIN 0
AXIS0 ILIMIT 0
AXIS0 IDELAY 0
AXIS0 DGAIN 1e-005
AXIS0 DWIDTH 0
AXIS0 FFVEL 0
AXIS0 FFACC 0
AXIS0 TLM 10
AXIS0 FBVEL 0
```

The next section is specific to the ACR9000 and does not apply to other ACR controllers. From the Fault dialog, the axis limit features are enabled and values fixed. Then the DAC gain is fixed, and the Axis is enabled.

```
REM Axis Limits
AXIS0 HLDEC 500
SET BIT16144
SET BIT16145
SET BIT16148
SET BIT16149
AXIS0 SLM (24,0)
AXIS0 SLDEC 500
CLR BIT16150
CLR BIT16151
DAC0 GAIN 3276.8
AXIS0 ON
```

The setup for axes 1 and 2 are similar to axis 0.

```
ATTACH AXIS1 ENC1 DAC1 ENC1
AXIS1 PPU 39999.999404
AXIS1 EXC (0.2,-0.2)
REM ACR Extended IO Settings
SET BIT8500
CLR BIT8496
CLR BIT8502
SET BIT8501
CLR BIT8485
CLR BIT8503
ENC1 SRC 0
ENC1 MULT 4
REM Axis Gains values
AXIS1 PGAIN 0.002441
AXIS1 IGAIN 0
AXIS1 ILIMIT 0
```

## Parker Hannifin

```

AXIS1 IDELAY 0
AXIS1 DGAIN 1e-005
AXIS1 DWIDTH 0
AXIS1 FFVEL 0
AXIS1 FFACC 0
AXIS1 TLM 10
AXIS1 FBVEL 0
REM Axis Limits
AXIS1 HLBIT 3
AXIS1 HLDEC 100
SET BIT16176
SET BIT16177
SET BIT16180
SET BIT16181
AXIS1 SLM (24,0)
AXIS1 SLDEC 100
CLR BIT16182
CLR BIT16183
DAC1 GAIN 3276.8
AXIS1 ON

ATTACH AXIS2 ENC2 DAC2 ENC2
AXIS2 PPU 39999.999404
AXIS2 EXC (0.2,-0.2)
REM ACR Extended IO Settings
SET BIT8532
CLR BIT8528
CLR BIT8534
SET BIT8533
CLR BIT8517
CLR BIT8535
ENC2 SRC 0
ENC2 MULT 4
REM Axis Gains values
AXIS2 PGAIN 0.002441
AXIS2 IGAIN 0
AXIS2 ILIMIT 0
AXIS2 IDELAY 0
AXIS2 DGAIN 1e-005
AXIS2 DWIDTH 0
AXIS2 FFVEL 0
AXIS2 FFACC 0
AXIS2 TLM 10
AXIS2 FBVEL 0
REM Axis Limits
AXIS2 HLBIT 6
AXIS2 HLDEC 100
SET BIT16208
SET BIT16209
SET BIT16212
SET BIT16213
AXIS2 SLM (6,0)
AXIS2 SLDEC 100
CLR BIT16214
CLR BIT16215
DAC2 GAIN 3276.8
AXIS2 ON
```

All the unused axes are turned off—this is done directly with the **AXIS OFF** command rather than using bits designated for this purpose. Turning off the axes reduces CPU load and increases system performance.

```

REM Turn off any unused Axes
AXIS3 OFF
AXIS4 OFF
AXIS5 OFF
AXIS6 OFF
AXIS7 OFF
```

## Parker Hannifin

```
REM Code Generated by ComACRsrvr Module, File Version: 1.1.2.9 @
Wednesday, March 15, 2006 17:00:43
REM Code Generated from map:program8k v1.1 CodeMap
File:C:\WINDOWS\system32\kjconfig.cmp v3.5
REM Program Level setup for the ACR Card
```

In the program space, the attachments are made. If you are writing your own configuration code, it is a good coding practice to include the a **DETACH** statement before the **ATTACH** statements. The Axis Name comes from the Axis dialog, the master/slave information comes from the Masters dialog, and the acceleration, deceleration, and stop ramps and velocity come from the Master dialog.

```
PROG0
DETACH
ATTACH MASTER0
ATTACH SLAVE0 AXIS0 "X"
ATTACH SLAVE1 AXIS1 "Y"

REM the desired master acceleration
ACC 10

REM the desired master deceleration ramp
DEC 10

REM the desired master stop ramp (deceleration at end of move)
STP 10

REM the desired master velocity
VEL 5

REM the desired acceleration versus time profile.
JRK 0
```

```
REM Code Generated by ComACRsrvr Module, File Version: 1.1.2.9 @
REM Wednesday, March 15, 2006 17:00:43
```

```
REM Code Generated from map:program8k v1.1 CodeMap
REM File:C:\WINDOWS\system32\kjconfig.cmp v3.5
```

```
REM Program Level setup for the ACR Card
```

```
PROG1
DETACH
ATTACH MASTER1
ATTACH SLAVE0 AXIS2 "Z"

REM the desired master acceleration
ACC 20

REM the desired master deceleration ramp
DEC 20

REM the desired master stop ramp (deceleration at end of move)
STP 20

REM the desired master velocity
VEL 10

REM the desired acceleration versus time profile.
JRK 0
```

### *Resources Reserved for Generated Code*

The Configuration Wizard reserves controller resources based on the controller, its firmware version, and the features you enable. When

you save the configuration, the wizard generates AcroBASIC code and saves it to specific user and PLC programs.

The Configuration Wizard saves all configuration data to a Setup.8K file. Depending on which controller and the firmware version, it may also save Drive I/O or Configuration Wizard data to various user and PLC program files.

**NOTE:** Do not edit the source files generated by the Configuration Wizard.

### Firmware Versions 1.18.15 and up (ACR9000 only)

The wizard generates AcroBASIC code and places it in the Setup.8K file. The Prog15.8K file contains the configuration wizard data.

### Firmware Versions Up to 1.18.14 (All ACR Controllers)

The wizard generates AcroBASIC code and places it in the Setup.8K file. The Prog7.8K, PLC5.8K, PLC6.8K, and PLC7.8K files contain the configuration wizard data and code for Hardware Limits, Software Limits, and Drive Fault (hardware-input based drive fault, or software-based following error drive fault) features.

PLC programs have limited memory space. If the resulting code exceeds the limit for a PLC program, the Configuration Wizard splits it among several PLC programs. The wizard uses the PLC5.8K file first, and uses the PLC6.8k and PLC7.8k files as needed.

**NOTE:** By default, the wizard matches motion profiles to programs of the same number. Because the wizard reserves the Prog7.8k file for the above-mentioned features, the MASTER07 motion profile definition is placed in the Prog08.8k file.

If no other programs are defined beyond the Prog08.8k file, the controller continues scanning programs 00-08 without delay. There is no delay executing the Prog08.8k file and MASTER07. If any of the programs Prog09 through Prog15 are used, then Prog08 will not execute as quickly as PROG00 to PROG07.S

### Global (P) Variables

The wizard generates code using global variables P100-P131 for Software end-of-travel limits routines. Each variable corresponds to a specific axis and direction of travel, as summarized below.

**NOTE:** Do not change these values in user programs unless specifically modifying them to change the end-of-travel limit.

- **P100-P115 Positive Software End-of-Travel Limits:** For example, P100 contains the value for Axis0, P101 for Axis1, etc.

- **P116-P131 Negative Software End-of-Travel Limits:** For example, P116 contains the value for Axis0, P117 for Axis1, etc.

### User Flags (Group 5-8)

The wizard generates code using bits 1952-2047 for drive-fault and end-of-travel routines. Each range of bits correspond to a range of axes and a specific drive or travel limit function, as summarized below.

Items marked with an asterisk (\*) apply only to 16-axis ACR series controllers. Therefore, an 8-axis controller can use the flags otherwise used for axes 8-16.

- **Bits 1952-1959 Drive Faulted Flag Axes 0-7:** Triggered by conditions that fault a drive (either hardware input or following error) and is used in the PLC program to stop motion on the specific axis.
- **Bits 1960-1967 Drive Faulted Flag Axes 8-15\*:** Triggered by conditions that fault a drive (either hardware input or following error) and is used in the PLC program to stop motion on the specific axis.
- **Bits 1968-1975 Drive Disabled Flag Axis 0-7:** Triggered when a drive is faulted (or optionally when motion is killed) and is used by the PLC program to set the Drive Disable output.
- **Bits 1976-1983 Drive Disabled Flag Axis 8-15\*:** Triggered when a drive is faulted (or optionally when motion is killed) and is used by the PLC program to set the Drive Disable output.
- **Bits 1984-1991 Drive Enable Flag Axis 0-7:** Triggered when a drive is faulted or disabled, the flag signals the Drive Enable function to clear the faulted condition and enable the drive.
- **Bits 1992-1999 Drive Enable Flag Axis 8-15\*:** Triggered when a drive is faulted or disabled, the flag signals the Drive Enable function to clear the faulted condition and enable the drive.
- **Bits 2000-2007 Software Limit Flag Axis 0-7:** Triggered when a software limit is hit.
- **Bits 2008-2015 Software Limit Flag Axis 8-15\*:** Triggered when a software limit is hit.
- **Bits 2016-2023 Hardware Positive Limit Flag Axis 0-7:** Triggered when a hardware limit is hit.
- **Bits 2024-2031 Hardware Positive Limit Flag Axis 8-15\*:** Triggered when a positive hardware limit is hit.
- **Bits 2032-2039 Hardware Negative Limit Flag Axis 0-7:** Triggered when a hardware negative limit is hit.
- **Bits 2040-2047 Hardware Negative Limit Flag Axis 8-15\*:** Triggered when a negative hardware limit is hit.

# Making Motion

---

Now that the controller is configured, it is ready to make motion. The ACR controller can perform linear, circular, or more complex motion with a single axis or multiple axes.

## Four Basic Categories of Motion

There are four basic categories of motion used in motion control: coordinated, jog, gear, and cam.

- **Coordinated Moves Profiler (Multi-Axis Profile):** Use the **MOV** command for linear-interpolated incremental and absolute moves. It also allows circular interpolation (**CIRCW**, **CIRCCW**, **SINE**, and **TARC**). The trajectory values are “path” values.
- **Jog Profiler (Single-Axis Profile):** Use the **JOG** commands for incremental, absolute, or continuous moves. The Jog Profiler is axis-independent, meaning that each axis uses its own trajectory values independent of other axes.
- **Gear Profiler (Electronic Gear):** Use the **GEAR** commands to control motion based on an external source—such as an electronic gearbox, trackball, follower axis, feed-to-length, or changes of ratio related to position.
- **Cam Profiler (Electronic Cam):** Use the **CAM** commands to control irregular motion using data tables. The Cam Profiler provides control of complex motion, and is best used in situations where the Gear Profiler is unable to perform satisfactorily.

Regardless of the type of motion or number of axes used, the controller must always be set up for coordinated motion. This may be done by using the Configuration Wizard or by writing custom configuration code, and including master, slave, and axis attachment statements. The attachment statements make the basic connections to a coordinated motion profiler. For more information, see [Attachments](#).

After making the necessary attachments, a motion profile can be defined. The following sections examine the different move types and motion profilers.



## Move Types

To command motion, use a command appropriate to the desired type of motion, such as **JOG** (single-axis profile), **CIRCW** (Two-Dimensional Clockwise Circle), **CIRCCW** (Two-Dimensional Counter Clockwise Circle), **SINE** (Sinusoidal Move), or **TARC** (3-D Arc) The **MOV** (Define a Linear Move) command activates linear-interpolated motion.

When the user includes several axes in a single statement, the controller coordinates the moves (meaning the axes complete their respective moves at the same time.) Whereas, if each axis is written as an independent statement, the controller treats them as independent moves and they are performed one at a time.

The **MOV** command is not necessary for coordinated motion because the controller recognizes an axis name and a value as commanded motion, such as X500. When multiple axes are written in a single statement, such as X500 Y100, the motion is coordinated.

**NOTE:** When commanding motion, you must use the axis name; the axis number is not a valid way to indicate an axis. For more information on Axis names, see [Slaves and Axis Names](#).

### Absolute Motion

Absolute motion is commanded with respect to the established "home" or reference location.

To make a linear-interpolated move with the **MOV** command, use the arguments *axis target*, specifying the axis name followed by the target position.

#### Example 1

The following moves the X axis to the absolute position of 10 units.

```
MOV X10
```

#### Example 2

To command linear-interpolated motion without **MOV**, the axis and position must be designated. The following also moves the X axis to the absolute position of 10 units in an identical manner as Example 1.

```
X10
```

#### Example 3

If motion is commanded for multiple axes on a single line, the controller treats it as coordinated motion. The X and Y axes complete their respective moves at the exact same time.

```
X20 Y-30
```

### Incremental Motion

Incremental motion is commanded relative to the current position.

To move an incremental distance (a distance “relative” to the current position), use a slash mark ( / ) following the axis.

**NOTE:** The slash mark is only applicable in linear-interpolated motion.

#### Example 1

In this example, the X axis moves an incremental distance of 20 units from its current position. Then the Y axis moves a decremental distance of 30 units from its current position.

```
X/20  
Y/-30
```

#### Example 2

The X axis makes an incremental move, Y axis makes an absolute move, and Z axis makes a decremental move. Written on the same line, this is a coordinated move; all axes complete their moves at the same time.

```
X/2 Y2 Z/-2
```

### Comparing Absolute and Incremental Motion

Different types of motion can be used to achieve the same result. The following examples show absolute and incremental motion, and a combination of the two. All three examples end at the absolute position of 400 units.

#### Example—Absolute Motion

The X axis is commanded to the following absolute positions:

```
X0  
X100  
X200  
X300  
X400
```

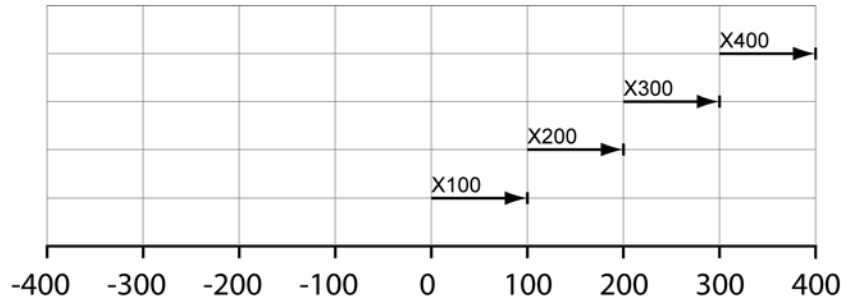

### Example—Incremental Motion

The X axis is commanded to the following relative positions:

```
X0
X/-400
X/500
X/200
X/100
```

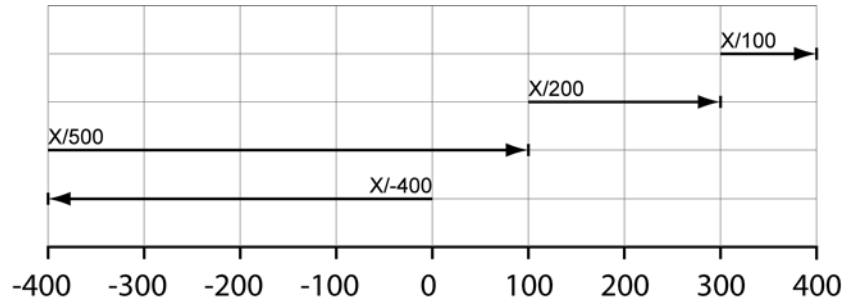

### Example—Absolute and Relative

The X axis is commanded to the following absolute and incremental positions.

```
x/-400
x200
x/50
x400
```

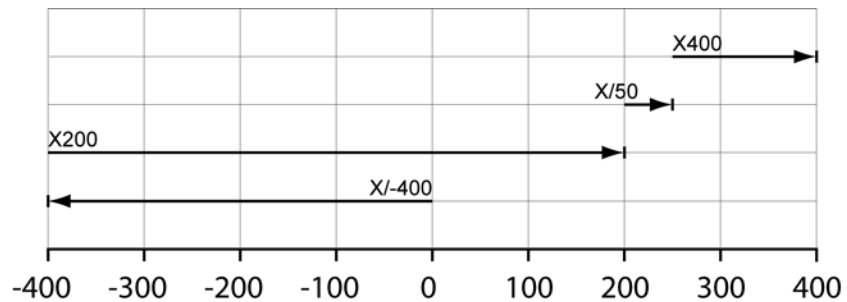

### Combining Types of Motion

The user can command multiple types of motion (linear, circular, or sinusoidal) in a single statement. The controller coordinates the motion of all axes in the statement regardless of the type of motion.

#### Example

The following illustrates a coordinated move where the X axis performs linear-interpolation and the Y axis performs sinusoidal interpolation.

```
X2 SINE Y(0,90,90,100)
```

## Immediate Mode

While a program is running, the master velocity can be changed for a master (and all axes attached to it). The change is instantaneous, and takes effect even if the axis or axes are moving.

Use the **FOV** (Set Feedrate Override) command to set a floating-point scaling factor to adjust the master velocity. If a move is in progress, the master uses the established acceleration or deceleration ramp to adjust to the new velocity.

**NOTE:** The **FOV** command does not change the master velocity permanently and the change is not saved. To make a permanent change, adjust the master velocity in the program code either manually or through the Configuration Wizard.

For more information about feedrate override, see the **FOV** command in the *ACR Command Language Reference*.

### Example

The following is typed in at the prompt by the user. It reduces the master velocity for all attached axes to 75%, then 50%, and then returns the velocity to 100%.

```
FOV 0.75
FOV 0.50
FOV 1.00
```

## Differences Between FOV and VEL

While a program is running, both the **FOV** and **VEL** (Set Target Velocity for a Move) commands can be set, but each affects motion differently:

- **FOV** immediately affects all axes attached to the master.
- **VEL** is buffered in memory. The newly commanded velocity does not take effect until current motion is completed.

## What are Motion Profiles?

To make motion, the user must define the motion profile. The acceleration, deceleration, stop ramps, velocity, and distance (**ACC**, **DEC**, **STP**, **VEL**, and **MOV** commands, respectively) set the motion profile values.

- **Acceleration:** The **ACC** (Set Acceleration Ramp) command sets the master acceleration. The master acceleration is used to ramp from lower to higher speeds. The value is in units per second <sup>2</sup>.
- **Velocity:** The **VEL** (Set Target Velocity for a Move) command sets the target velocity for subsequent moves. The value is in units per second.
- **Deceleration:** The **DEC** (Set Deceleration Ramp) command sets the deceleration used to ramp from higher to lower speeds. The value is in units per second <sup>2</sup>.

The deceleration ramp is only used when the stop ramp is zero. Use the **DEC** ramp to blend moves.

- **Stop:** Use the **STP** (Set Stop Ramp) command to set the master deceleration ramp used at the end of the next move. The value is in units per second <sup>2</sup>.

When the stop ramp is set to zero, the move ends without ramping down. This allows you to merge back-to-back moves. The final velocity of the first move becomes the initial velocity of the second move.

Motion profiles can be graphically represented. The following illustrates the **ACC**, **DEC**, and **STP** values as a typical trapezoidal motion profile.

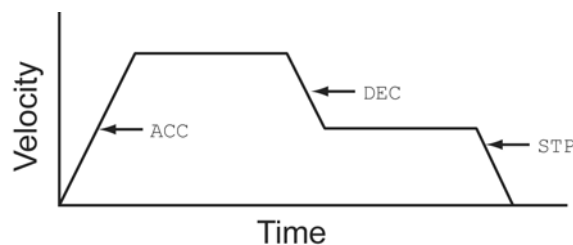

All motion profile values are entered in user-based units (inches, millimeters, degrees, revolutions, or other units). Use the **PPU** (Set Axis Pulse per Unit Ratio) command to relate the feedback pulse to the unit of measure. (The **PPU** command sets the ratio of pulses per programming unit.) The controller computes the motion trajectory from the motion profile data.

Motion profile values for each master can be set in two ways:

- ▶ Through the Configuration Wizard.
- ▶ In a program using the appropriate motion profile statements (**ACC**, **DEC**, **STP**, or **VEL**).

In either case, the program continues to use those motion profile values until new values are commanded.

**NOTE:** Motion profile values in a specific program can be changed from within a different program using the **MASTER** (Direct Master Access) command. A master must be attached to each program, and is usually the same number as the program number. For more information about masters, see [Master/Slave Attachments](#).

For example, to change the velocity in program zero to 500, send the following: `MASTER0 VEL500`.

### Example

The following example assumes a 1000 line encoder attached to a motor. The **MULT** (Set Encoder Multipliers) command brings the value to 4000. Then `PPU X4000` sets the programming units to revolutions (4000 pulses/rev) for the rest of the program. The X axis moves 200 revolutions at 20 revs/second, using 10 revs/second<sup>2</sup> ramps.

```
MULT X4
PPU X4000
ACC 10
DEC 10
STP 10
VEL 20
MOV X200
```

## Interaction Between Motion Profilers

Any combination of motion profilers can be used to carry out motion for an application. As stated previously, the controller must be set up for coordinated motion. Once this is done, the other motion profilers can be accessed through the **JOG**, **GEAR**, and **CAM** commands.

Before writing code, it is important to understand how the motion profilers interrelate.

- Each motion profiler calculates its own commanded position—the absolute and relative moves for an axis or axes.
- No motion profiler supersedes another; there is no hierarchy among the profilers.

## Primary Setpoint

All profilers feed their commanded positions to a summation point, and the result is the Primary Setpoint for each axis. See Figure 1.

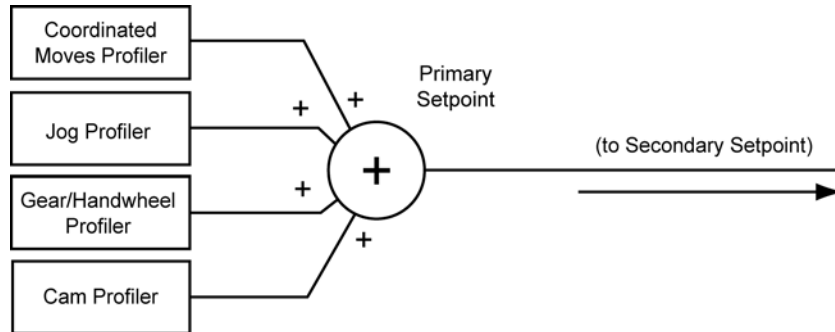

Figure 1 Primary Setpoint Summation

In effect, the Jog, Gear, and Cam profilers act as offsets to the Coordinated Motion Profiler. The example below demonstrates the offset concept.

### Example

Suppose an application cuts four diamond shapes from sheets of stock. The program commands motion of axes X, Y, and Z. For simplicity, this example focuses only on the X and Y axes.

Rather than plotting the cutting motion by providing the coordinates for each diamond, the code in this example provides the coordinates for one diamond and uses the Jog Profiler to offset the coordinates for the remaining diamonds.

The axes are attached to a Coordinated Moves Profiler (see [Master/Slave Attachments](#)). The cutting tool starts at coordinates (0, 0) in the lower left quadrant of the stock. Subsequent diamonds are cut in sequence from upper left, upper right, and lower right quadrants. The first shape is cut based on the following moves:

```
X-2 Y1
X0 Y2
X2 Y1
X0 Y0
```

For the second shape, instead of providing a new set of X and Y coordinates, a jog statement is used to shift the Y axis 3 units. You can then provide the same coordinates used to cut the first shape. The new starting position becomes coordinates (0, 3).

```
JOG ABS Y3
X-2 Y1
X0 Y2
X2 Y1
X0 Y0
```

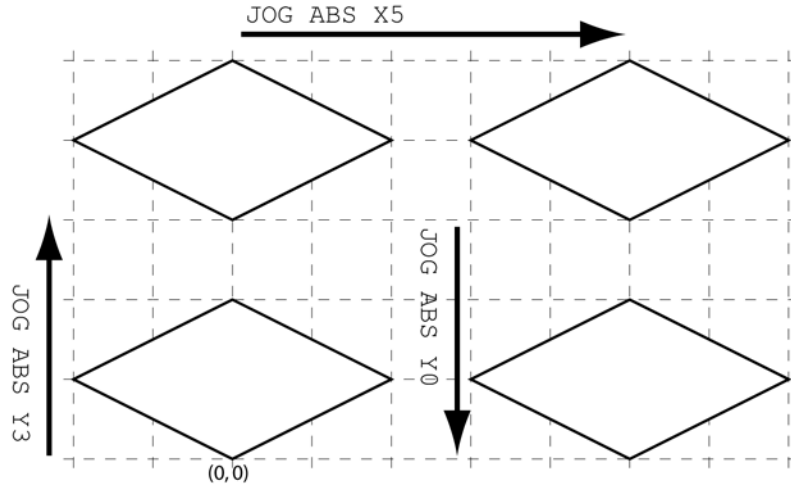

To cut the third and fourth diamond shapes, jog statements again shift the starting positions for axes X and Y. After each jog statement, the coordinates of the first shape are reused.

```
JOG ABS X5
X-2 Y1
X0 Y2
X2 Y1
X0 Y0
```

```
JOG ABS Y0
X-2 Y1
X0 Y2
X2 Y1
X0 Y0
```

So what is happening? Each motion profiler calculates its own commanded position, which is sent to a summation point. The coordinated move, jog, gear, and cam data is combined for each axis to create a setpoint.

The Coordinated Moves Profiler always starts and ends at coordinates (0, 0). With the first shape, there are no **JOG**, **GEAR**, or **CAM** commands, so the setpoint for the X and Y axes is (0,0):

Summation Point	X Axis	Y Axis
Coordinated Moves Profiler	0	0
Jog Profiler	0	0
Gear Profiler	0	0
Cam Profiler	0	0
<hr/>		
SETPOINT	0	0



For the second shape, the jog statement tells the Jog Profiler to start the Y axis at 3 units. At the summation point, this data is added to the values from the other profilers to yield a Y-axis setpoint of +3:

<b>Summation Point</b>	<b>X Axis</b>	<b>Y Axis</b>
Coordinated Moves Profiler	0	0
Jog Profiler	0	+3
Gear Profiler	0	0
Cam Profiler	0	0
<hr/>		
SETPOINT	0	+3

For the third shape, the jog statement adjusts the starting point again, this time changing the X axis to 5. The Y axis has not been jogged so it stays at its previous value of +3:

<b>Summation Point</b>	<b>X Axis</b>	<b>Y Axis</b>
Coordinated Moves Profiler	0	0
Jog Profiler	+5	+3
Gear Profiler	0	0
Cam Profiler	0	0
<hr/>		
SETPOINT	+5	+3

For the fourth shape, the jog statement adjusts the starting point for the Y axis back to 0. The X axis has not been jogged so it stays at its previous value of +5:

<b>Summation Point</b>	<b>X Axis</b>	<b>Y Axis</b>
Coordinated Moves Profiler	0	0
Jog Profiler	+5	0
Gear Profiler	0	0
Cam Profiler	0	0
<hr/>		
SETPOINT	+5	0

Without offsets, coordinates for each shape would have to be calculated (and debugged). Instead, one set of coordinates can be reused and the starting point shifted through an offset.

## Velocity Profile Commands

A basic motion profile for coordinated motion, controlled by an attached master, consists of acceleration, deceleration, stop ramps and a velocity. You can further control coordinated motion using additional velocity profile commands.

Axis motion with gear, cam, or jog offsets are controlled solely by their associated commands—for example, **CAM OFFSET**, **CAM SCALE**, **GEAR ACC**, **GEAR RATIO**, **JOG DEC**, or **JOG JRK**.

**NOTE:** To check the setting of a specific motion profile command, enter the command without any arguments.

**NOTE:** To disable a command, set its value to zero.

Use the **ESAVE** command to save coordinated motion and feedback control values in the controller. Otherwise, the system parameters, motion profiles, and master and axis attachments are retained by the controller only until the controller is rebooted or its power cycled. Then all data reverts to its default values.

### Velocity Profile Setup

The following commands further shape and refine the coordinated motion profile. For more information about each command, see the *ACR Command Language Reference*.

- **F** (Set Velocity in Units per Minute)—sets a move velocity in units/minute. The **F** command otherwise functions the same as the **VEL** command.
- **FOV** (Set Feedrate Override)—sets the move velocity manually, without changing the current **VEL** value. Use **FOV** to superimpose an additional move onto existing motion. Typically, the **FOV** provides a manual way to change velocity from a terminal. You can also assign the **FOV** to an input, providing users a manual way to initiate the superimposed move. For more information, see [Immediate Mode](#).
- **FVEL** (Set Final Velocity)—sets a final velocity value. When a **STP** value has been set, **FVEL** can be used to set a target final velocity value. The value is used to slow down between moves, but not stop. Moreover, a move only ramps down to the **FVEL** value, never up to the value.
- **JRK** (Set Jerk Parameter)—sets the slope of acceleration versus time profile. An s-curve profile provides a smoother motion control by reducing the jerk (rate of change) in acceleration and deceleration portions of the move profile. Because s-curve profiling reduces jerk, it improves position tracking performance.

- **ROTARY** (Set Rotary Axis Length)—sets a rotary axis length used in a shortest-distance calculation. The resulting move is never longer than half the rotary axis length.
- **TMOV** (Time Based Move)—sets the time (in seconds) in which the move is completed. The controller calculates a new master motion profile to complete the move in the specified time. The new motion profile values for acceleration, deceleration, stop ramps, and velocity are no greater than the user-specified values.
- **VECDEF** (Define Automatic Vector)—controls how the Coordinated Moves Profiler calculates the master move vector. The **VECDEF** command defines the weight each axis receives in the vector calculation. The default value is 1 for every axis.

In some applications, it is not desirable to include an axis in the motion profile calculation. Suppose there is an application with coordinated motion for axes X, Y, and Z, and rotary axis A. Setting the axis A value to zero removes it from the vector calculation. Axis A makes its move within the defined motion profile, but is not part of the calculation itself.

- **VECTOR** (Set Manual Vector)—sets an independent vector value for an axis removed from the motion profile calculation through the **VECDEF** command. Because the axis is no longer part of the motion profile calculation, it has no master velocity with which it can make independent moves. The **VECTOR** command provides that value so the axis can make independent moves.

## *Feedback Control Commands*

The feedback control commands affect the velocity profiles and define the encoder feedback used by axes in the current program. Values must be set for each axis.

- **MULT** (Set Encoder Multipliers)—sets the count direction and the hardware multiplication for the encoder of a given axis. This command affects tuning gains, directions, distances, velocities, and accelerations.



**Caution** —Damage to equipment and/or serious injury to personnel may result if **MULT** is changed to a value inappropriate to the application.

Carefully consider the effects throughout the application before applying a new value, and perform a test without the load or mechanics attached.

- **PPU** (Set Axis Pulse per Unit Ratio)—sets the pulses per programming unit for an axis, allowing convenient units for motion profile such as inches, millimeters, or degrees. The PPU for each axis is independent of that of other axes.



**Caution** —Damage to equipment and/or serious injury to personnel may result if **PPU** is changed to a value inappropriate to the application.

Carefully consider the effects throughout the application before applying a new value, and perform a test without the load or mechanics attached.

- **REN** (Match Position with Encoder)—sets the commanded position equal to the actual position for a given axis, thus removing the following error.
- **RES** (Reset or Preload Encoders)—sets the commanded position and actual encoder position to zero for a given axis. It also allows the user to pre-load an axis with a position.

### REN Details

The REN command copies the actual position from the encoder into the Secondary Setpoint of the servo loop. The values for the Primary Setpoint register and for the Coordinated Moves Profiler's offset are then calculated backwards from the Secondary Setpoint. This action removes the following error.

In the example in Figure 2, the actual position is 11. That number is copied into the register for the Secondary Setpoint, and the Primary Setpoint is then calculated (11).

The Jog, Gear, and Cam profilers' offsets do not change. The values in their registers are subtracted from the Primary Setpoint to get the offset for the Coordinated Moves Profiler:

$$11 - [2 + 3 + 4] = 2$$

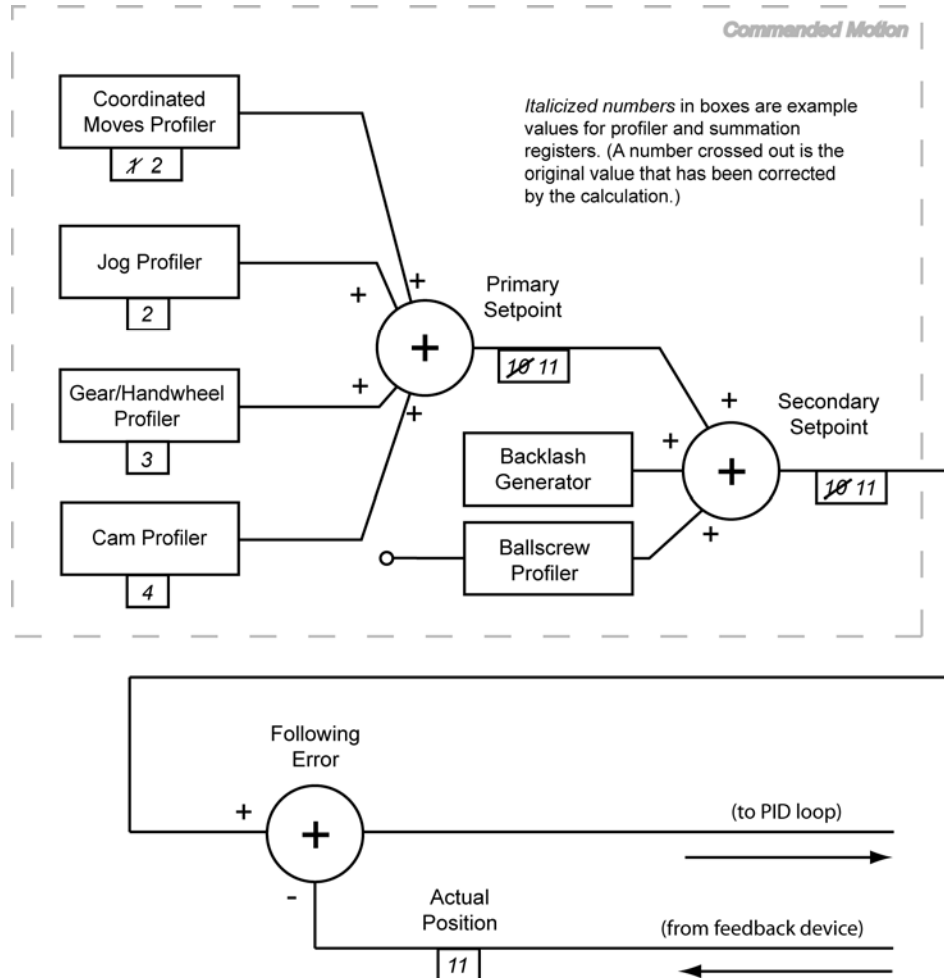

Figure 2 Calculations for REN Command

## RES Details

The **RES** command is used to zero out the primary setpoint (**RES**), or to preload positions into the Coordinated Moves Profiler and Actual Position registers (example: **RES X10**).

See Figure 3 for a diagram of the profiler and summation registers for the command **RES X10**. The values of the Coordinated Moves Profiler, Primary and Secondary Setpoints, and Actual Position registers have been changed to 10. The remaining profilers have been changed to zero.

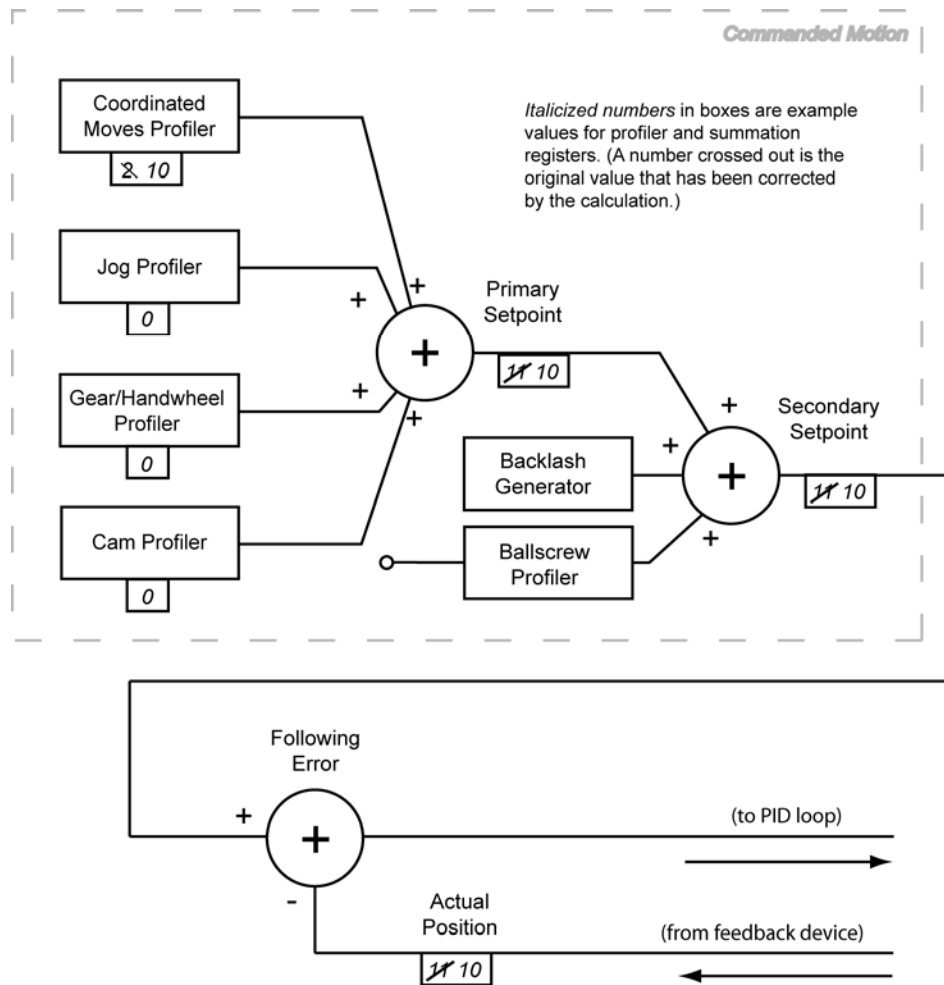

Figure 3 Register Values for **RES X10**

If **RES** is used without an axis and preload value, all the registers shown in Figure 3 would be zero (0).

## Coordinated Moves Profiler

The Coordinated Moves Profiler (formerly called the *current position profiler*) controls motion for multiple axes using a single set of motion profile values. The **MOV** command (Define a Linear Move) commands absolute and incremental motion.

**NOTE:** The **MOV** command is not necessary for coordinated motion. The controller recognizes the axis name and a value as commanded motion, such as X500.

Multiple axes can be commanded in a single code statement, such as X500 Y100; the motion is coordinated.

No matter what the designed application is, the controller must first be configured for coordinated (linear interpolated) motion. This does not limit the user from simultaneously using the other motion profilers—jog, gear, or cam. Information regarding which elements it is working with is provided to the Coordinated Moves Profiler by the master, slave, and axis attachment statements. The other motion profilers look to the Coordinated Moves Profiler for the configuration data. For more information about making attachments, see [Attachments](#).

When multiple axes are moving, the Coordinated Moves Profiler computes the vector based on all the axes target points. The vector moves at the values set through the motion profile (**ACC**, **DEC**, **STP**, and **VEL**), and is scaled for each axis. Therefore, all axes start, accelerate, decelerate, and stop at the same time.

When only one axis is moving, the **ACC**, **VEL**, and **STP** are the same as the master.

**NOTE:** The Coordinated Moves Profiler typically uses the clock as its timebase.

### Example 1

Two axes are attached to the same master and instructed to move to absolute positions: axis X to 25 millimeters and axis Y to 15 millimeters. All axes start, accelerate, decelerate, and stop together.

```
ACC 750 DEC 750 VEL 75 STP 750
X25 Y15
```

## Parker Hannifin

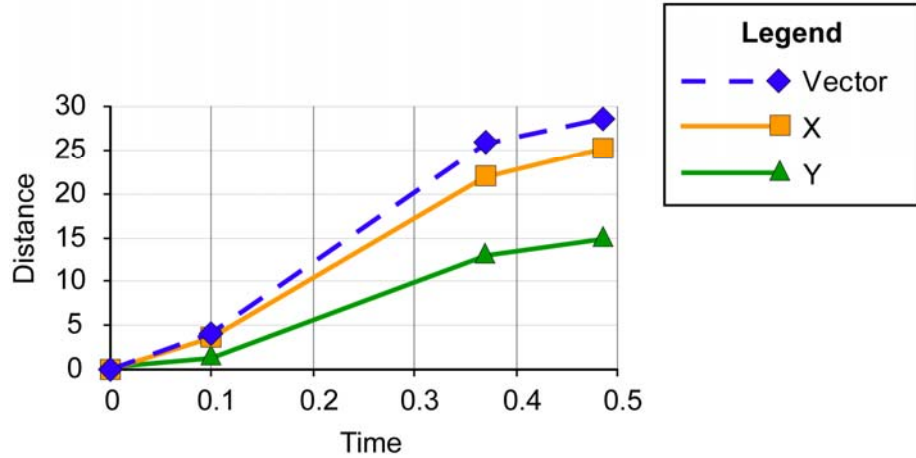
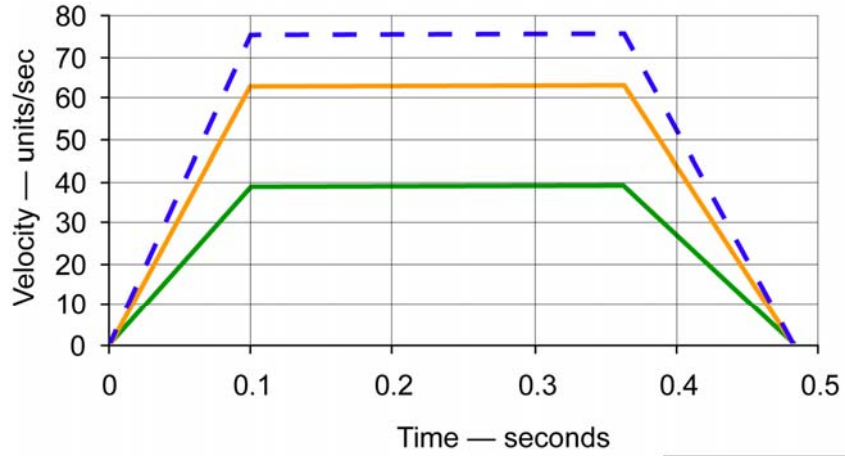

### Example 2

Two axes are attached to the same master, and the program moves one axis to an absolute position: axis X to 25 millimeters. As only axis X is commanded to move, axis Y is not included in the motion trajectory calculation.

```
ACC 750 DEC 750 VEL 75 STP 750  
X25
```



Parker Hannifin

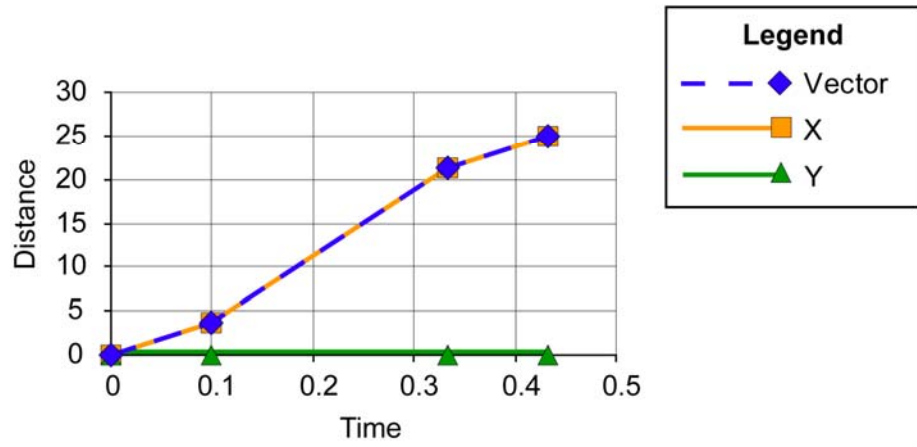
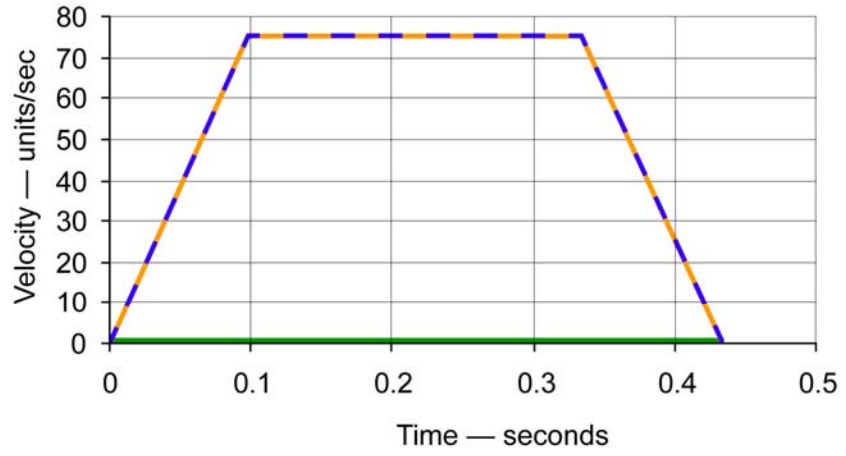

## Jog Profiler

Each axis has a dedicated Jog Profiler which can, using a set of motion profile values, control absolute, incremental, or continuous motion for that axis. It can do this independently or in conjunction with the other profilers (Cam, Gear, and Coordinated Moves).

**NOTE:** Multiple axes may be commanded in a single jog statement, such as `JOG ABS X500 Y100`. The motion is not coordinated.

For any application, the controller is first configured for coordinated motion. This does not exclude simultaneously using the other motion profilers.

The Jog Profiler looks to the Coordinated Moves Profiler for its configuration data (master, slave, and axis attachment statements). For more information about making attachments, see [Attachments](#).

The Jog Profiler computes motion based on axis target positions and on the motion profile values (**JOG ACC**, **JOG DEC**, **JOG JRK**, and **JOG VEL**). The motion profile is scaled by the PPU (pulses per programming unit) for each axis. All axes may start, accelerate, and decelerate at different times.

**NOTE:** The Jog Profiler typically uses the clock as its timebase.

**NOTE:** The ACR controller uses the Jog Profiler for jogging and homing routines. If the acceleration, deceleration, velocity, and jerk values are set for jogging, those values are also used for homing. Therefore, it is a good programming practice to declare the motion profile at the beginning of every jog subroutine. Doing so ensures the correct motion values are used for a jogging or homing routine, regardless how the program branches to a subroutine.

**NOTE:** The Configuration Wizard contains a Jog/Home Commissioning dialog. The dialog only allows the user to test the setup of an axis—it does not produce jogging or homing code.

### Example 1

Two axes are set to different acceleration, deceleration, and velocities, and are moved the same distance.

```
JOG ACC X1000 Y500
JOG DEC X1000 Y500
JOG VEL X25 Y50
JOG INC X10 Y10
```

Figure 4 looks at the commanded motion of the X axis. In the upper graph (velocity motion profile), **JOG ACC** and **JOG DEC** determine the acceleration and deceleration values, which always graph as ascending and descending slopes, respectively. **JOG VEL** always graphs as a horizontal line once the axis is up to speed. The area under the velocity profile graph is the distance traveled.

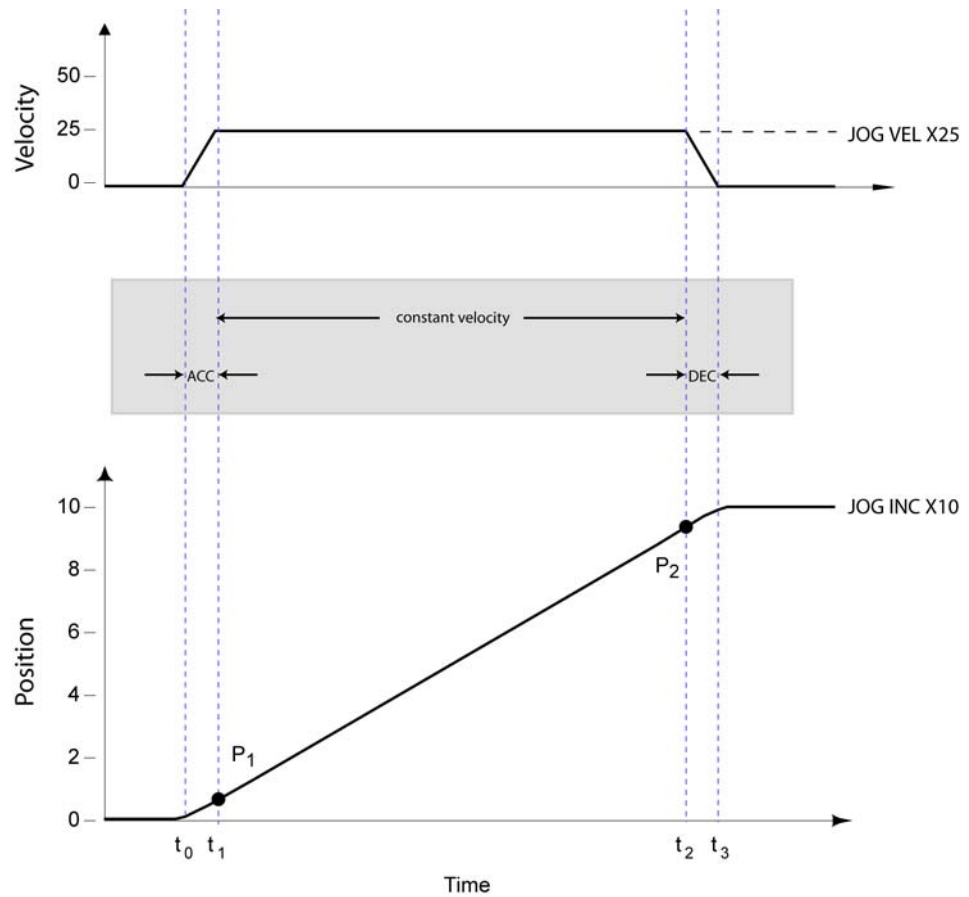

Figure 4 X-Axis Velocity and Position Profiles

In the lower graph (position motion profile) of Figure 4, the curve between  $t_0$  and  $t_1$  shows the change in position during the time it takes for the X axis to accelerate from zero to the target velocity. Likewise, the curve between  $t_2$  and  $t_3$  shows the change in position during deceleration to zero. (The actual acceleration and deceleration curves shown are approximated due to the resolution of the graph.) The straight line between points  $P_1$  and  $P_2$  is where the X-axis movement is a constant velocity.

Figure 5 looks at the movement for the Y axis, characterized by more gradual slopes for acceleration and deceleration values of 500 in the velocity motion profile (as compared to the X-axis' values of 1000).

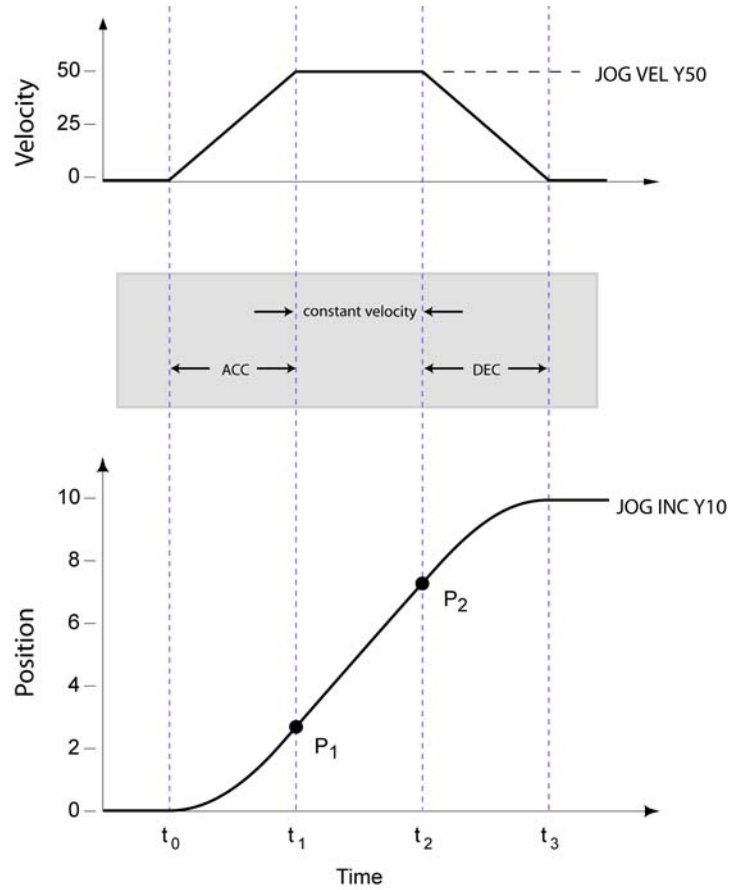

Figure 5 Y-Axis Velocity and Position Profiles

Again, the straight line between points P<sub>1</sub> and P<sub>2</sub> on the position motion profile is where the Y-axis movement is a constant velocity.

Figure 6 shows the velocity motion profiles for both the X and Y axes superimposed. The Y axis is dashed. Due to a higher **JOG VEL** value, the Y axis finishes its commanded motion in less time than the X axis.

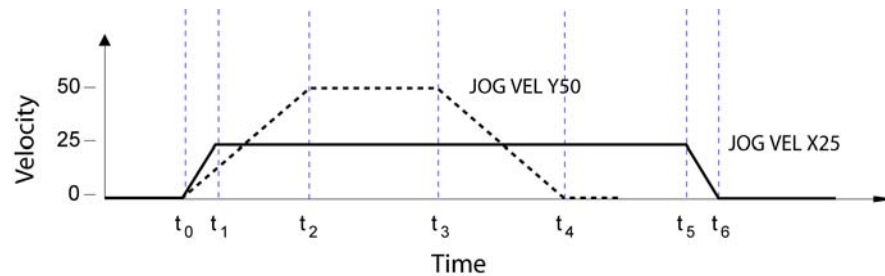

Figure 6 X and Y Velocity Motion Profiles

Figure 7 graphs the change in position for the X and Y axes. The Y axis is dashed. The overall slope of the position curve for the Y axis is steeper, reflecting its higher **JOG VEL** value (JOG VEL X25 Y50).

Comparing the first curve after  $t_0$  for the axes show that a higher acceleration value presents as a more gradual curve (JOG ACC X1000 Y500).

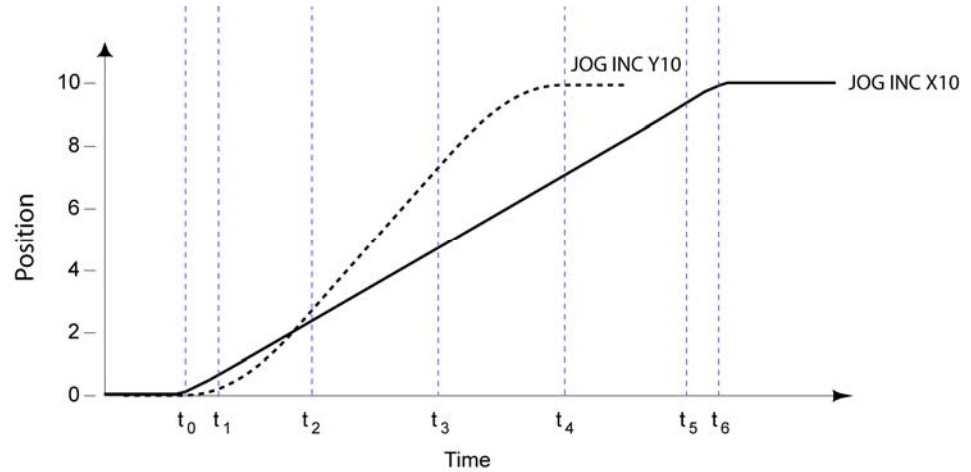

Figure 7 X and Y Position Motion Profiles

### Example 2

The **JOG VEL** value is changed while a single axis is in motion (on the fly (OTF)).

```
JOG ACC X20
JOG DEC X25
JOG VEL X10
JOG INC X10
DWL 1.0
JOG VEL X5
```

At one second ( $t_0 + 1.0$  sec.), the axis is commanded to decrease speed to the new velocity. See Figure 8 for the velocity profile. Motion ends at  $t_1$ .

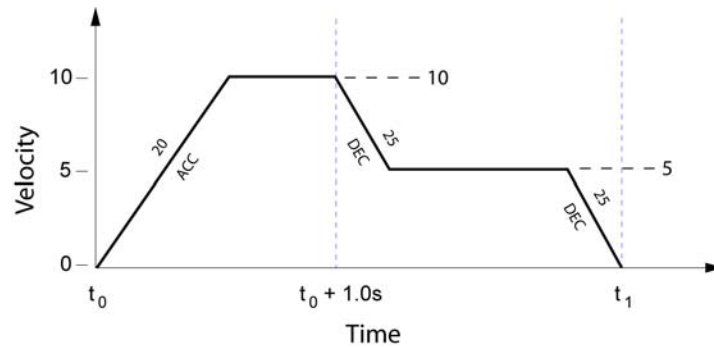

Figure 8 Change in JOG VEL Value "On the Fly"

### Example 3

To illustrate sequential jog moves, two axes are attached to the same program. The program moves each axis an incremental distance of 10 units using two separate moves. The program waits until the Jog Active Bit (Bit792) is off, indicating that Axis X has finished its move, after which time the Y axis is commanded to move to its incremental position. Figure 9 shows the velocity profile of this example.

```
JOG ACC X1000 Y500
JOG DEC X1000 Y500
JOG VEL X25 Y50
JOG INC X10
INH -792
JOG INC Y10
```

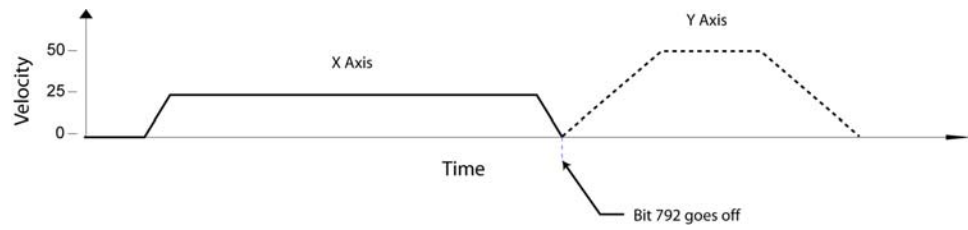

Figure 9 Velocity Profile of Sequential Jog Moves

## JOG VEL Details

Figure 10 shows the bit profiles for the Jog Flags (Bits 792 through 796) as a JOG VEL command is executed.

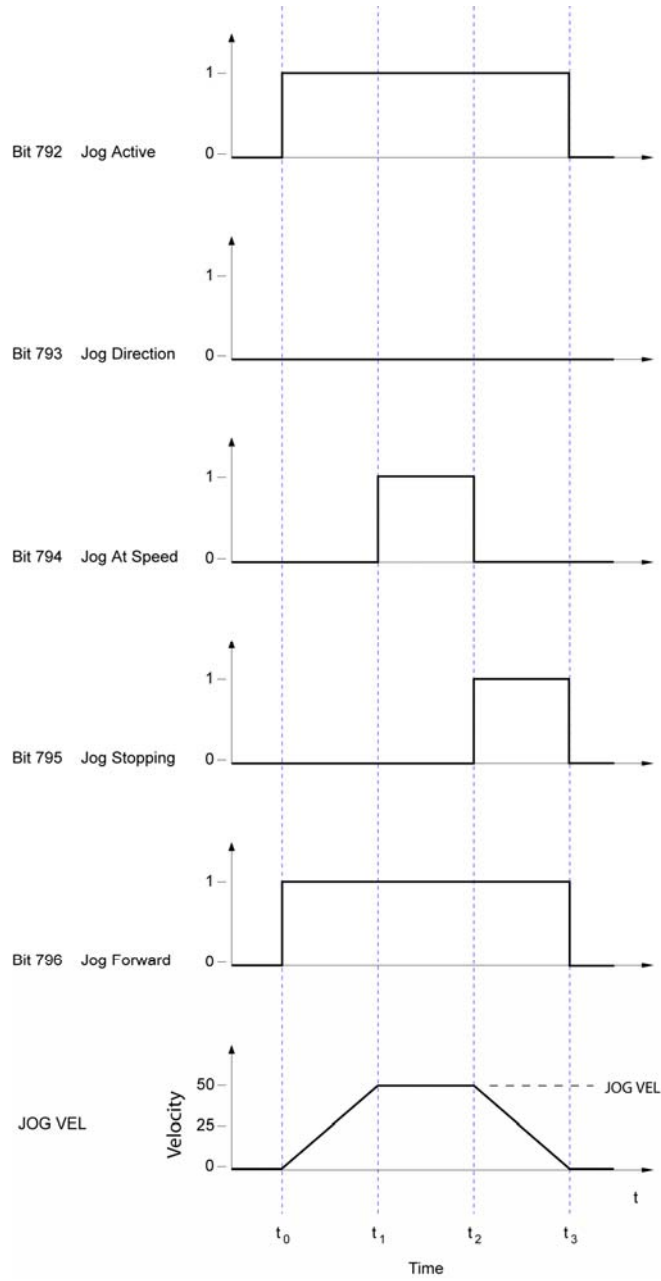

Figure 10 JOG VEL Command and Bit Profiles

## *JOG Commands*

See the *ACR Command Language Reference* for detailed information, including necessary arguments, on **JOG** (Single Axis Velocity Profile) and its associated commands:

- **JOG ABS** (Jog to Absolute Position)—uses the current jog settings to jog an axis to an absolute jog offset.
- **JOG ACC** (Set Jog Acceleration)—sets the programmed jog acceleration for an axis.
- **JOG DEC** (Set Jog Deceleration)—sets the programmed jog deceleration for an axis.
- **JOG FWD** (Jog Axis Forward)—initiates a ramp to the velocity programmed by the **JOG VEL** command.
- **JOG HOME** (Go Home)—instructs the controller to search for the home position in the direction and on the axes specified.
- **JOG HOMVF** (Home Final Velocity)—specifies the velocity to use when the homing operation makes the final approach.
- **JOG INC** (Jog an Incremental Distance)—uses the current jog settings to jog an axis an incremental distance from the current jog offset.
- **JOG JRK** (Set Jog Jerk (S-curve))—controls the slope of the acceleration versus time profile.
- **JOG OFF** (Stop Jogging Axis)—initiates a ramp down to zero speed.
- **JOG REN** (Transfer Current Position into Jog Offset)—either clears or preloads the current position of a given axis and adds the difference to the jog offset parameter.
- **JOG RES** (Transfer Jog Offset Into Current Position)—either clears or preloads the jog offset of a given axis and adds the difference to the current position.
- **JOG REV** (Jog Axis Backward)—initiates a ramp in the negative direction to the velocity programmed with the **JOG VEL** command.
- **JOG SRC** (Set External Timebase)—specifies the timebase for jogging.
- **JOG VEL** (Set Jog Velocity)—sets the programmed jog velocity for an axis.



## JOG REN Details

The **JOG REN** command (Transfer Current Position into Jog Offset) clears the Coordinated Moves Profiler of a given axis and adds the difference to the Jog Profiler offset (example: `JOG REN X`). It can also be used to preload a position into the Coordinated Moves Profiler (adjusting the Jog Profiler to make up the difference) (example: `JOG REN X2`). In either case, the Gear and Cam profilers and the Primary and Secondary setpoints do not change.

The drawing in Figure 11 illustrates **JOG REN** as it clears the Coordinated Moves Profiler.

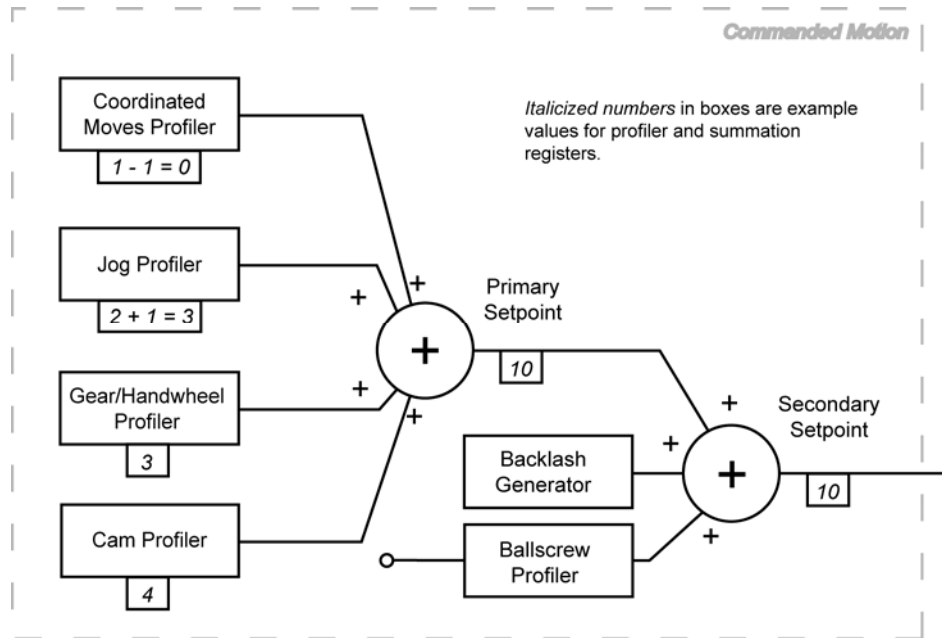

Figure 11 **JOG REN** Clears Coordinated Moves Profiler (`JOG REN X`)

The drawing in Figure 12 illustrates **JOG REN** as it preloads the Coordinated Moves Profiler.

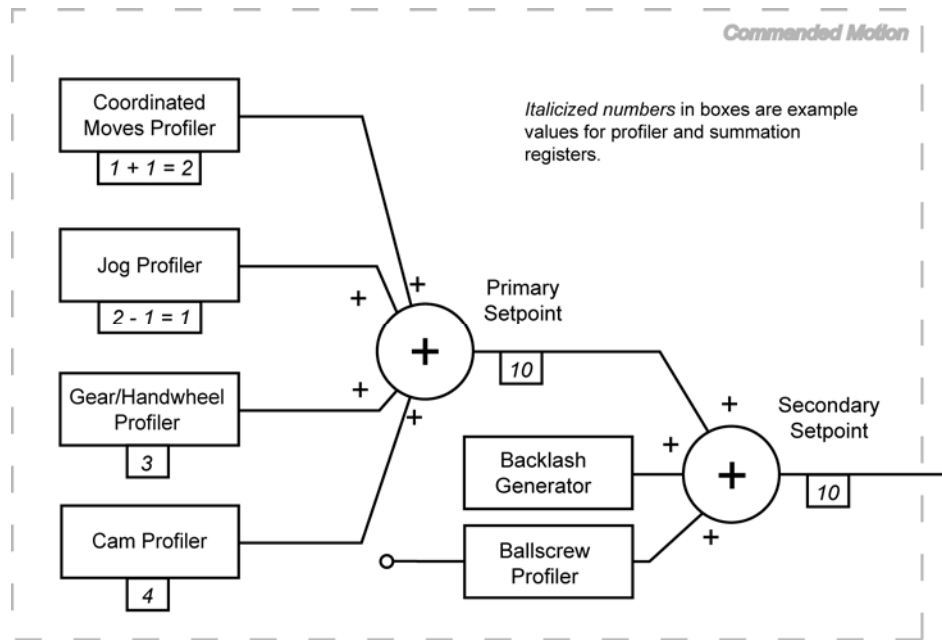

Figure 12 **JOG REN** Preloads the Coordinated Moves Profiler (**JOG REN X2**)

## JOG RES Details

The **JOG RES** command (Transfer Jog Offset Into Current Position) clears the Jog Profiler offset of a given axis, and adds the difference to the Coordinated Moves Profiler (example: `JOG RES X`). It can also preload the Jog Profiler offset, and, again, adjusts the Coordinated Moves Profiler to make up the difference (example: `JOG RES X2`). In either case, the Gear and Cam profilers and the Primary and Secondary setpoints do not change.

The drawing in Figure 13 illustrates **JOG RES** as it clears the Jog Profiler.

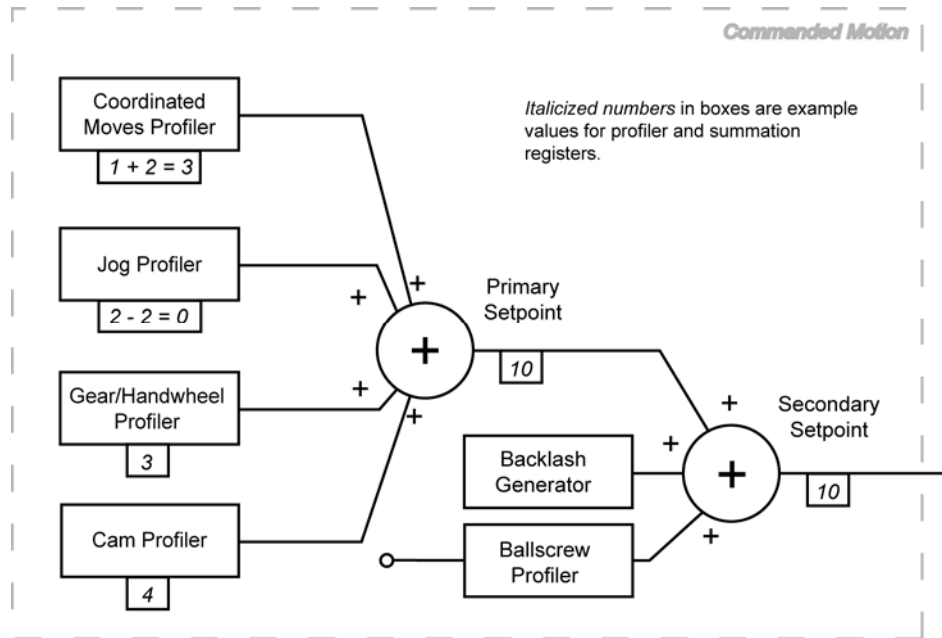

Figure 13 **JOG RES** Clears Jog Profiler (`JOG RES X`)

The drawing in Figure 14 illustrates **JOG RES** as it preloads the Jog Profiler.

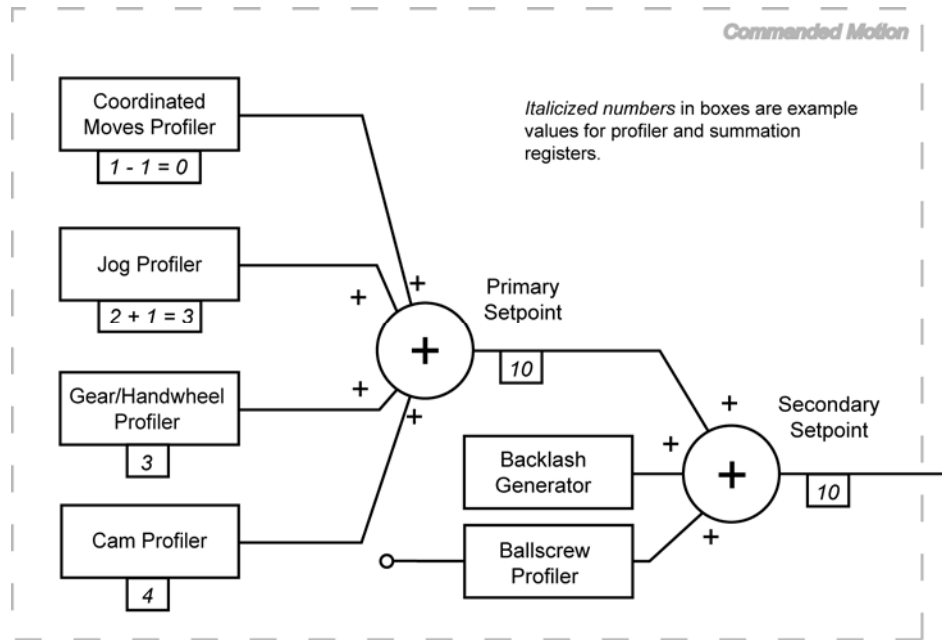

Figure 14 **JOG RES** Preloads the Jog Profiler (*JOG RES X2*)

## Gear Profiler

The Gear Profiler controls motion for axes needing to match their motion output to some form of input (see **SRC** command—Set External Timebase—for available sources). The input source is usually external, such as an electronic gearbox, trackball, follower axis, or changes of ratio related to position.

**NOTE:** The Gear Profiler typically uses a source other than the clock as its timebase.

- **GEAR RES** (Reset or Preload Gearing Output)—this command either clears or preloads the gear offset for the given axis.

## Cam Profiler

The Cam Profiler controls motion for axes needing precise motion. It uses an array of target points in relation to an externally sourced timebase (see **SRC** command—Set External Timebase—for available sources). By breaking the motion into discrete target points, the cam arrives at the exact point needed.

The Cam Profiler provides linear interpolation between points, regardless of how many points are necessary for the move. All changes in motion are real time. The Cam Profiler does not compile motion.

**NOTE:** The Cam Profiler typically uses a source other than the clock as its timebase.

- **CAM RES** (Transfer Cam Offset)—this command either clears or preloads the cam offset of a given axis and adds the difference to the current position. It also clears out any cam shift that may have been built up by an incremental cam.

## Homing

The homing operation is a sequence of moves that position an axis using the Home Limit inputs. The goal of the homing operation is to return the load to a repeatable starting location.

When the homing operation successfully completes, the controller sets the absolute position register to zero, establishing a zero reference position. For servo axes using analog feedback, the controller sets the voltage register to zero.

The Jog Profiler controls homing operations. If the acceleration, deceleration, velocity, and jerk values are set for jogging, those values are also used for homing.

**NOTE:** It is a good programming practice to declare the motion profile at the beginning of every jog subroutine. Doing so ensures the correct motion values are used for a jogging or homing routine, regardless how the program branches to a subroutine.

**NOTE:** A homing routine cannot be started for an axis that is already in motion.

**NOTE:** Relevance of positive and negative direction—

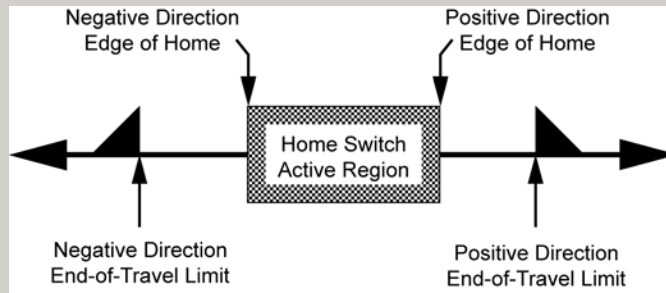

**NOTE:** If an end-of-travel limit is encountered during the homing operation, motion is reversed and the home switch is sought in the opposite direction. If a second limit is encountered, the homing operation is terminated, stopping motion at the second limit.

**NOTE:** For homing operations, always use the clock as the source of the Jog Profiler.

The controller uses the following guidelines for all backup-enabled profiles:

- Search for the selected edge at the velocity set with the **JOG VEL** command (Set Jog Velocity).
- Use the direction given in the **JOG HOME** command (Go Home). If the home input is already active, start toward the selected edge. On finding the selected edge, decelerate.
- Return to the selected edge at the velocity set with the **JOG HOMVF** command (Home Final Velocity). If the returning direction is the same as the selected final direction, the profile is complete. Otherwise, find the edge again in the selected final direction (using the velocity set with the **JOG HOMVF** command).

### Example

The homing routine sets the conditions for homing; a motion profile, the inputs related to homing, and homing velocity. In addition, specific bit conditions are set out. The **JOG HOME** command then starts the homing process.

The **WHILE/WEND** statement (Loop Execution Conditional) causes the program to wait until the homing conditions it contains are met. In the first AND statement, axis 0 cannot have found home and cannot have failed to find home. The second AND statement does the same for axis 1. Once conditions are met, the code within the **WHILE/WEND** statement is executed.

Finally, the program prints that the Y axis homing is successful, and initiates Z channel homing (**MSEEK** command—Marker Seek Operation) for axis X. When axis X has successfully completed the Z channel homing, the program prints that X axis homing is successful.

## Parker Hannifin

```
JOG VEL X10 Y10 : REM Set axes jog parameters used during homing
JOG ACC X100 Y100
JOG DEC X100 Y100

HLBIT X0 Y3 : REM X uses 1Home (input2), Y uses 2Home (input5)
HLIM X3 Y3 : REM enable EOT limit checking for box axes

JOG HOMVF X0.1 Y0.1 : REM Set backup to home velocity
SET 16144 SET 16145 : REM Invert axis0 level of limit inputs
SET 16176 SET 16177 : REM Invert axis1 level of limit inputs
CLR 16152 CLR 16184 : REM Disable backup to home
CLR 16153 CLR 16185 : REM Look for positive edge of sensor
CLR 16154 CLR 16186 : REM Final homing direction will be positive

JOG HOME X-1 Y1 : REM start homing x negative, y positive

REM The WHILE/WEND statement uses Boolean logic to define homing
REM conditions. Bits 16134 and 16166 are the Found Home bits for axes
WHILE ((NOT BIT 16134) AND (NOT BIT 16135)) OR ((NOT BIT 16166) AND (NOT
BIT 16167)))
WEND

IF (BIT 16166) THEN PRINT "Y HOMING SUCCESSFUL"
IF (BIT 16134)
  MSEEK X(1,0)
  INH -516
  IF (BIT 777)
    PRINT "X HOMING SUCCESSFUL"
  ENDIF
ENDIF

ENDP
```

### Homing Subroutines

Typically, the homing code is a subroutine in a program. The Jog commands define the motion (**JOG ACC**, **JOG DEC**, **JOG HOME**, **JOG HOMVF**, **JOG JRK**, and **JOG VEL**), and three bits in the Quinary Axis Flags (Bit16128-Bit16639) control other aspects of a homing routine.

- Home Backup Enable (bit index 24).
- Home Negative Edge Select (bit index 25).
- Home Final Direction (bit index 26).

The **JOG HOME** command simultaneously homes multiple axes. The arguments *axis direction* allow the user to specify an axis and the direction in which it seeks the homing region. For example **JOG HOME X1 Y-1** homes the X axis in the positive direction, and the Y axis in the negative direction.

The following diagrams illustrate the combinations and interactions of the three homing bits (above) and the **JOG HOME** command.

### Basic Homing (Homing Backup Disabled)

When the Home Backup Enable bit (Bit 24) is clear, the controller ignores the Home Negative Edge Select bit (Bit 25) and Home Negative Final Direction bit (Bit 26). Consequently, when the controller finds any homing edge (positive or negative), the move decelerates. The controller does not attempt to back up to the found edge.

Figures A and B show the homing operation when the Home Backup Enable, Home Negative Edge Select, and Home Negative Final Direction bits are clear (Quinary Axis Flags, Bit16128-Bit16639).

**Figure A**

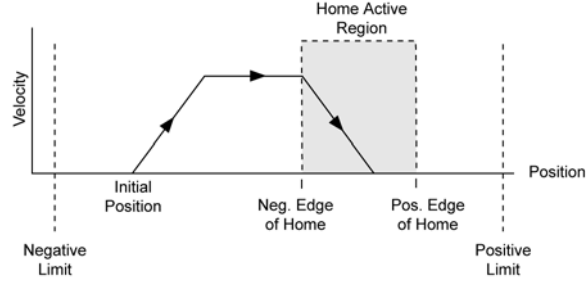

Homing Profile Attributes:

- JOG HOME X1
- Home Backup Enable (bit index 24) is clear.
- Home Negative Edge Select (bit index 25) is clear.
- Home Negative Final Direction (bit index 26) is clear.

**Figure B**

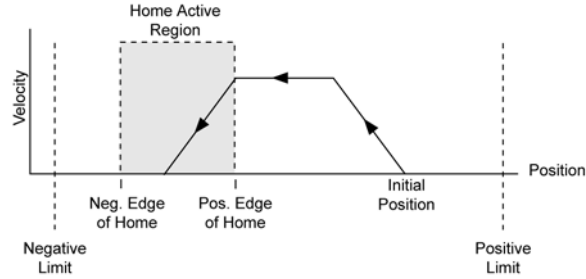

Homing Profile Attributes:

- JOG HOME X -1
- Home Backup Enable (bit index 24) is clear.
- Home Negative Edge Select (bit index 25) is clear.
- Home Negative Final Direction (bit index 26) is clear.



## Positive Homing (Homing Backup Enabled)

Figures C through F show the homing operation when the Home Backup Enable bit is set (parameters 4600-4615).

The seven steps below describe a sample homing operation, as illustrated in Figure C. Figures D through F show the homing operation for different values of the Home Negative Edge Select and Home Negative Final Direction bits—the Home Backup Enable bit is set.

1. A positive home move is started with the `JOG HOME X1` command at the **JOG ACC** and **JOG JRK** accelerations. Default **JOG ACC** is 10 revs (or volts or inches) per sec<sup>2</sup>.
2. The **JOGVEL** velocity is reached (move continues at that velocity until home input goes active).
3. The negative edge of the home input is ignored and the move continues until the positive edge is detected. At this time the move is decelerated at the **JOG DEC** and **JOG JRK** command values.
4. After stopping, the direction is reversed and a second move with a peak velocity specified by the **JOG HOMVF** value is started.
5. This move continues until the positive edge of the home input is reached.
6. Upon reaching the positive edge, the move is decelerated at the **JOG DEC** and **JOG JRK** command values, the direction is reversed, and another move is started in the positive direction at the **JOG HOMVF** velocity.
7. As soon as the home input positive edge is reached, this last move is immediately terminated. The load is at home and the absolute position register is reset to zero.

Figure C

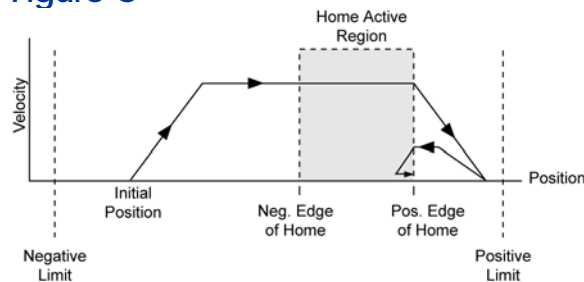

### Homing Profile Attributes:

- `JOG HOME X1`
- Home Backup Enable (bit index 24) is set.
- Home Negative Edge Select (bit index 25) is clear.
- Home Negative Final Direction (bit index 26) is clear.

Figure D

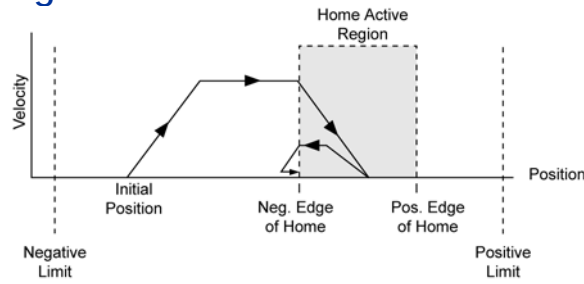

Homing Profile Attributes:

- JOG HOME X1
- Home Backup Enable (bit index 24) is set.
- Home Negative Edge Select (bit index 25) is set.
- Home Negative Final Direction (bit index 26) is clear.

Figure E

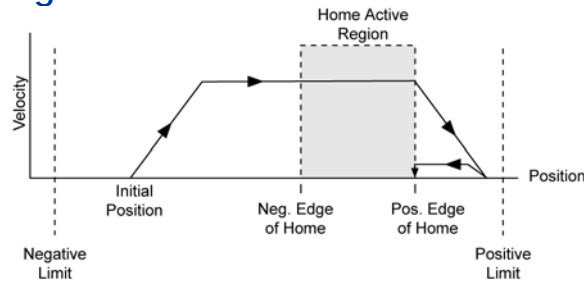

Homing Profile Attributes:

- JOG HOME X1
- Home Backup Enable (bit index 24) is set.
- Home Negative Edge Select (bit index 25) is clear.
- Home Negative Final Direction (bit index 26) is set.

Figure F

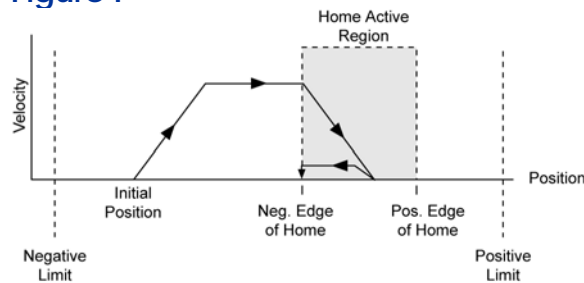

Homing Profile Attributes:

- JOG HOME X1
- Home Backup Enable (bit index 24) is set.
- Home Negative Edge Select (bit index 25) is set.
- Home Negative Final Direction (bit index 26) is set.

## Negative Homing (Homing Backup Enabled)

Figures G through J show the homing operation for different values of the Home Negative Edge Select and Home Negative Final Direction bits—the Home Backup Enable bit is set.

Figure G

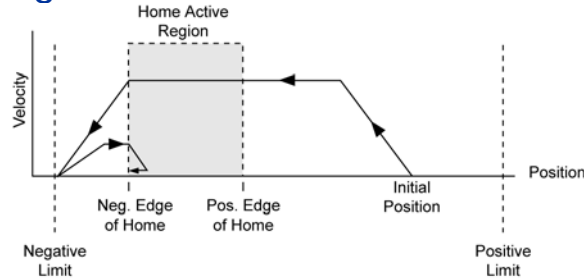

Homing Profile Attributes:

- JOG HOME X-1
- Home Backup Enable (bit index 24) is set.
- Home Negative Edge Select (bit index 25) is set.
- Home Negative Final Direction (bit index 26) is set.

Figure H

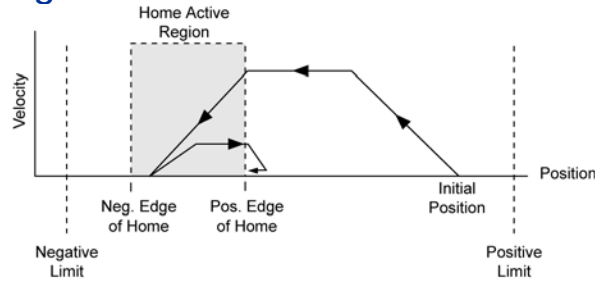

Homing Profile Attributes:

- JOG HOME X-1
- Home Backup Enable (bit index 24) is set.
- Home Negative Edge Select (bit index 25) is clear.
- Home Negative Final Direction (bit index 26) is set.

Figure I

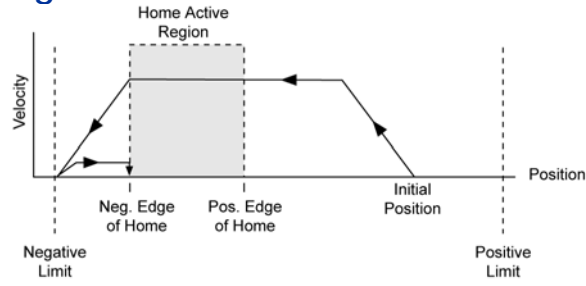

Homing Profile Attributes:

- JOG HOME X-1
- Home Backup Enable (bit index 24) is set.
- Home Negative Edge Select (bit index 25) is set.
- Home Negative Final Direction (bit index 26) is clear.

Figure J

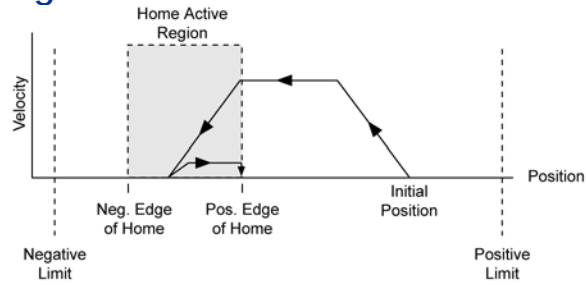

Homing Profile Attributes:

- JOG HOME X-1
- Home Backup Enable (bit index 24) is set.
- Home Negative Edge Select (bit index 25) is clear.
- Home Negative Final Direction (bit index 26) is clear.

## Limit Detection

The Configuration Wizard assists with setting up the Hardware and Software Limits Detection.

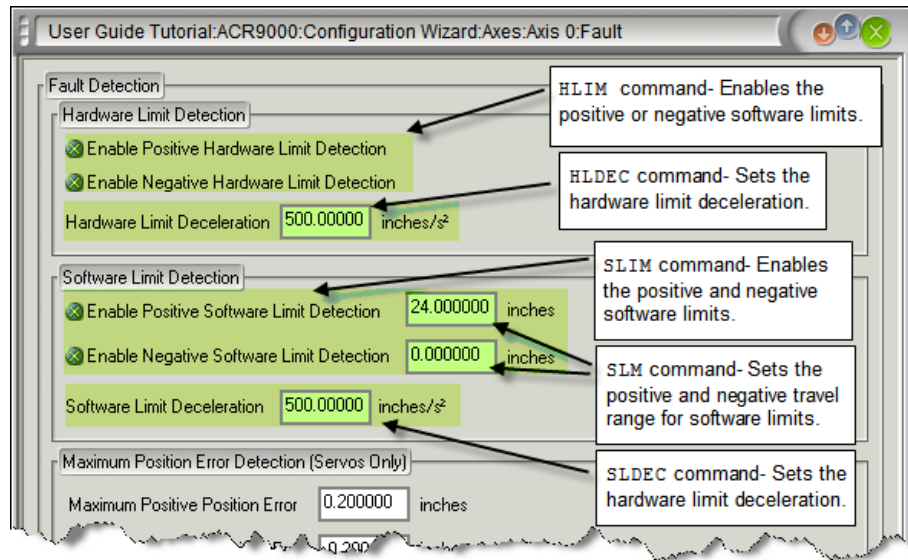

When limits are enabled, motion stops when the load encounters a limit. If the load hits a hardware limit, motion stops at the rate set by the **HLDEC**; if the load hits a software limit, motion stops at the rate set by the **SLDEC**.

## Dedicated I/O for Homing

For each axis, the user can assign which inputs are used for positive and negative hardware limits, and the input used for homing. The inputs can be assigned or changed using the **HLBIT** command (no corresponding parameter exists).

Use the **HLBIT** command to set the input for the positive hardware limit, and the controller sets the next two contiguous inputs for the negative hardware limit and homing.

For example, to assign input three as the positive hardware limit for axis Y, send the command `HLBIT Y3`; as a result, input 3 becomes the positive hardware limit, input 4 becomes the negative hardware limit, and input 5 becomes the homing input.

**NOTE:** There are no restrictions regarding how to assign hardware limits and homing inputs. However, you should exercise caution because it is possible to create imaginary limit and home inputs. This is because the controller assumes all three inputs are in the same multiple of 32 bits. The assignment of inputs does not roll over to the next block of 32 bits. For example, if the positive hardware limit is assigned to input 31, the negative hardware limit and homing inputs are not assigned. Instead, they become imaginary inputs with a value of zero.

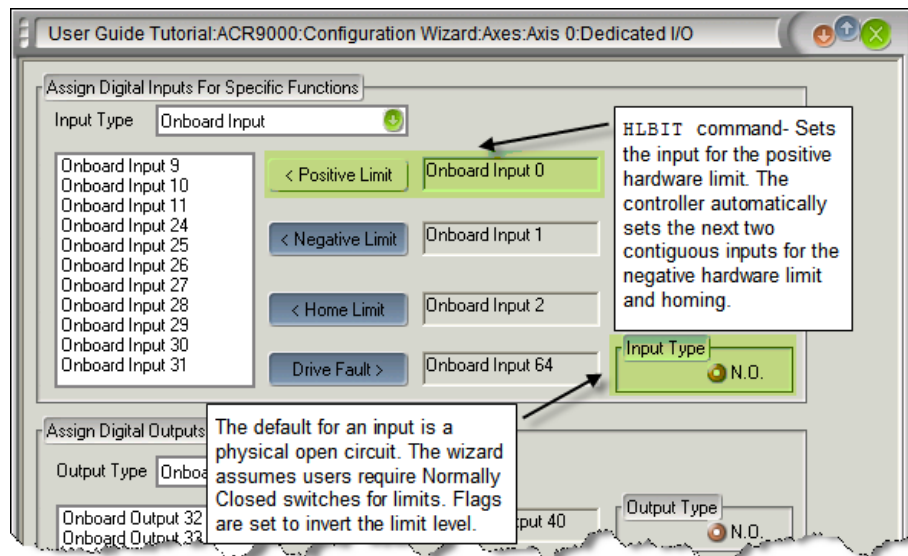

# Servo Loop Fundamentals

Each of the profilers contains a register with a value of the current offset. These values are added together and the summation is called the Primary Setpoint (PSP).

$$PSP = \text{Coordinated Moves} + \text{Jog} + \text{Gear} + \text{Cam}$$

See Figure 15 for a diagram of the Primary Setpoint summation.

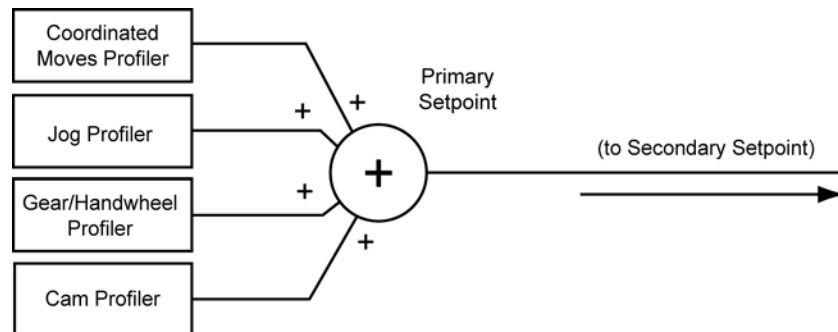

Figure 15 Primary Setpoint Summation

## Setpoint Compensation

There are two mechanical characteristics that the controller takes into consideration and compensates for: hysteresis losses and non-linear position error, which are processed by the Backlash Generator and Ballscrew Profiler, respectively.

- **Backlash Generator:** Used to compensate for error introduced by hysteresis in mechanical gearboxes. Backlash is used in the Secondary Setpoint summation if the Primary Setpoint value is positive. (Use the **BKL** command—Set Backlash Compensation—to set the compensation, or, without an argument, to display the current setting for an axis.)
- **Ballscrew Profiler:** Used to compensate for non-linear position error introduced by mechanical ballscrews and gearboxes. (Use the **BSC** command—Ballscrew Compensation—to initialize and control ballscrew compensation for an axis.)

The values of the Backlash Generator and Ballscrew Profiler are added to the Primary Setpoint, and this summation is called the Secondary Setpoint (SSP).

$$SSP = PSP + \text{Backlash} + \text{Ballscrew}$$

The information up to and including the SSP is the commanded position. See Figure 16.

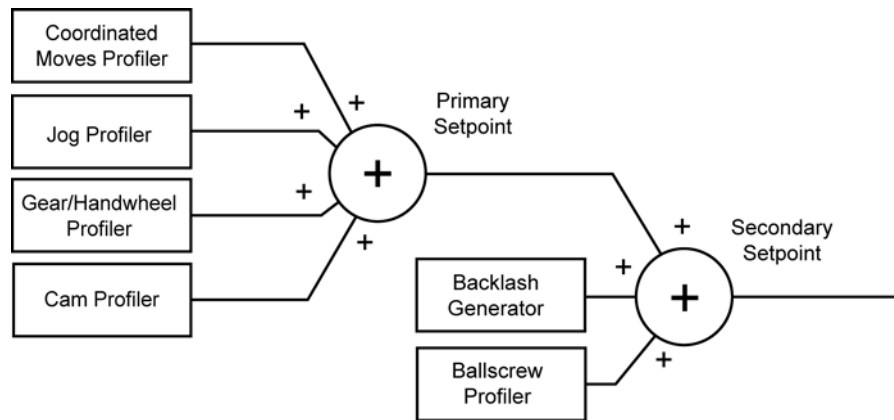

Figure 16 Secondary Setpoint Summation

### Viewing the Setpoint Calculations

Servo loop calculations for the actual position of an axis can be observed in ACR-View. The Servo Loop Status window shows the motion offsets, primary and secondary setpoints, servo gains and other values, and how they result in the final position output.

- ▶ In the Project Workspace, click **Status Panel**, then click **Servo Loop Status**.

## Following Error

The Secondary Setpoint is compared with the value of the Actual Position received from a feedback device. See Figure 17. The difference between the Secondary Setpoint and Actual Position is called the Following Error:

$$\text{Following Error} = \text{SSP} - \text{ACT POS}$$

The controller makes adjustments to the motor position through a constant cycle of comparison and correction. Following Error is used by the PID loop (servo control algorithm) to keep the Actual Position equal (or approaching equal to) the Secondary Setpoint.



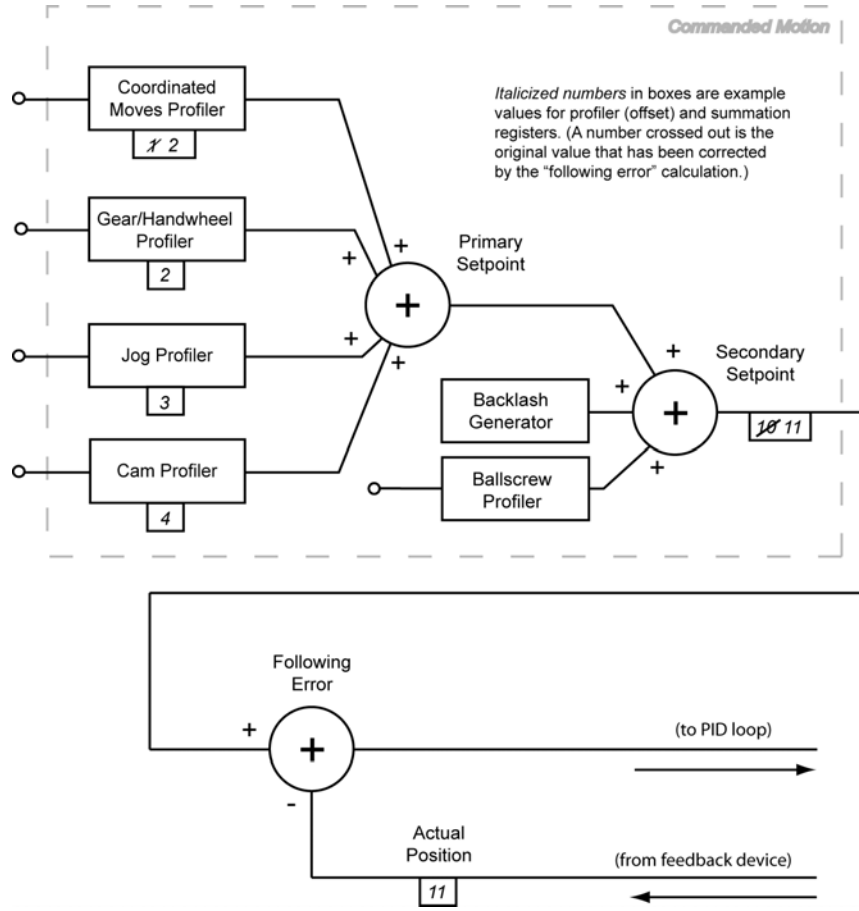

Figure 17 Following Error

# Application Examples

---

The sample programs in this section provide more in-depth examination of the following topics:

[Basic Motion](#)

[Enable Drive](#)

[EPL Network](#)

[Homing](#)

[Open Sample](#)

[Teach Array](#)

## Basic Motion

```

PROGRAM

GOSUB BasicABSMotion : REM subroutine for absolute moves
GOSUB BasicINCMotion : REM subroutine for incremental moves
GOSUB BasicCOMBOMotion
REM subroutine for combination of absolute and incremental moves
GOSUB JogABSMotion : REM subroutine for absolute jog moves
GOSUB JogINCMotion : REM subroutine for incremental jog moves
GOSUB JogCOMBOMotion
REM subroutine for combination of absolute and incremental jog moves

END

'SUBROUTINE OF Basic Absolute Moves
_BasicABSMotion

'ABSOLUTE MOVES
X0
X100
X200
X300
X400
INH -516
RETURN

'SUBROUTINE OF Basic Incremental Moves
_BasicINCMotion

X/-800
X/500
X/200
X/100
INH -516
RETURN

'SUBROUTINE OF Basic both Absolute and Incremental Moves
_BasicCOMBOMotion
X/-400
X200

```

## Parker Hannifin

```
X/50
X400
INH -516
RETURN

'SUBROUTINE OF Jog Absolute Moves
_JogABSMotion
JOG ABS X-400
INH -792
JOG ABS X-300
INH -792
JOG ABS X-200
INH -792
JOG ABS X-100
INH -792
JOG ABS X0
INH -792
RETURN

'SUBROUTINE OF Jog Incremental Moves
_JogINCMotion
JOG INC X-800
INH -792
JOG INC X500
INH -792
JOG INC X200
INH -792
JOG INC X100
INH -792
RETURN

'SUBROUTINE OF both Absolute and Incremental Moves
_JogCOMBOMotion
JOG INC X-400
INH -792
JOG ABS X-200
INH -792
JOG INC X50
INH -792
JOG ABS X0
INH -792
RETURN

ENDP
```

## Enable Drive

```
PROGRAM

GOSUB ENABLEDRIVE : REM GO TO SUBROUTINE "ENABLEDRIVE"

END

'SUBROUTINE OF ENABLEDRIVE
_ENABLEDRIVE

DRIVE ON X Y : REM TURNS ON OUTPUT TO ENABLE DRIVE

DWL 0.2 : REM WAIT 2ms

IF (BIT 8465) THEN PRINT "Axis0 is enable"
REM AXIS0 IS ENABLE, PRINT MESSAGE
IF (bit 8497) THEN PRINT "Axis1 is enable"
REM AXIS1 IS ENABLE, PRINT MESSAGE

IF (NOT BIT8465) THEN PRINT "Axis0 is not enable"
```

## Parker Hannifin

```
REM AXIS0 IS NOT ENABLE, PRINT MESSAGE
IF (NOT bit8467) THEN PRINT "Axis1 is not enable"
REM AXIS1 IS NOT ENABLE, PRINT MESSAGE

RETURN : REM RETURN BACK TO GOSUB

ENDP
```

## EPL Network

```
#DEFINE ResetEPLNetwork BIT150

PROGRAM

GOSUB EnableEPLNetwork : REM GO TO SUBROUTINE EnableEPLNetwork

END

'SUBROUTINE OF EnableEPLNetwork
_EnableEPLNetwork

INH 16648 : REM CHECK FOR CONTROLLER TO ACKNOWLEDGE EPL CARD

IF (NOT Bit16649) THEN EPLC ON
REM IF EPL NETWORK NOT OPERATIONAL, THEN START EPLC NETWORK

DWL 0.2

WHILE (BIT 16640)
REM INFINITE LOOP THAT WAITS TO EPL NETWORK TO START
WEND

IF (BIT 16649) THEN PRINT "EPL NETWORK OPERATIONAL"
REM IF NETWORK OPERATIONAL, PRINT MESSAGE TO SCREEN

'IF THE NETWORK IS NOT OPERATIONAL AT
'THIS POINT THEN TRY TO RESET IT

'IF NETWORK IS NOT OPERATIONAL, PRINT MESSAGE TO SCREEN
IF (BIT 16650) THEN PRINT "EPL NETWORK START FAILED, GOING TO RESET
NETWORK"

IF (NOT BIT 16649)
    EPLC OFF : REM RESET EPL NETWORK
    SET ResetEPLNetwork : REM SET RESET EPL NETWORK LATCHED BIT
    INH -16657 : REM INHIBIT PROGRAM UNTIL EPL NETWORK RESETS
    EPLC ON : REM START EPL NETWORK AGAIN
    INH -16656
    REM INHIBIT PROGRAM UNTIL START EPL NETWORK HAS FINISHED
ENDIF

'CHECK IF EPL NETWORK IS STILL NOT OPERATIONAL
'AND ALREADY RESET NETWORK

IF ((NOT BIT 16649) AND (ResetEPLNetwork))
PRINT "EPL network problem occurred."
ENDIF

ENDP
```

# Homing

## Homing Example 1

```

PROGRAM

GOSUB HOMING : REM GO TO SUBROUTINE HOMING

END

'SUBROUTINE HOMING
_HOMING
JOG VEL X1 Y1 : REM Set axes jog parameters used during homing
JOG ACC X10 Y10
JOG DEC X10 Y10

HLBIT X0 Y3
'X uses PosEOT (input0), NegEOT (input1), Home (input2)
'Y uses PosEOT (input3), NegEOT (input4), Home (input5)

JOG HOMVF X0.1 Y0.1 : REM Set backup to home velocity

JOG HOME X-1 Y1 : REM start homing x negative, y positive

'Infinite WHILE statement while both are still trying to HOME
WHILE (((NOT BIT 16134) AND (NOT BIT 16135)) AND ((NOT BIT 16166) AND (NOT
BIT 16167)))
WEND

'Prints Information regarding "Y" Axis homing
IF (BIT 16166) THEN PRINT "Y HOMING SUCCESSFUL" : SET 128
IF (BIT 16167) THEN PRINT "Y HOMING UNSUCCESSFUL"

'Checks if "X" Axis homing successful. If successful, the axis
'will look for the index marker.

ACC 10 : REM set motion profile for mseek incremental move
DEC 10
VEL 0.5
STP 10
IF (BIT 16134)
  MSEEK X(1,0) : REM Performs search for index marker in 1 incremental
unit move
  INH -516 : REM Waits for Master to Not be "IN MOTION"
  IF (BIT 777) : REM if Capture of Index Marker was complete
    PRINT "X HOMING SUCCESSFUL" : REM Prints information
    SET 129
  ENDIF
ENDIF
'If "X" Axis did not Home Successful, Print information
IF (BIT 16135) THEN PRINT "X HOMING UNSUCCESSFUL"

RETURN

ENDP

```

## Homing Example 2

### Homing Example XYZ System

```

PROG0
PROGRAM

GOSUB EnableDrives
GOSUB HomeAll
REM insert application code here
END : REM end program

_EnableDrives
DRIVE ON X Y Z
DWL 0.15
REM wait 150ms for servos to enable before commanding moves
RETURN

_HomeAll
HLIM X3 : REM enable limits
HLIM Y3 : REM enable limits
HLIM Z3 : REM enable limits
JOG ACC X500 : REM set jog accel for homing
JOG DEC X500 : REM set jog decel for homing
JOG VEL X100 : REM set jog velocity for homing
JOG HOMVF X25 : REM set jog final velocity for homing
JOG ACC Y300 : REM set jog accel for homing
JOG DEC Y300 : REM set jog decel for homing
JOG VEL Y75 : REM set jog velocity for homing
JOG HOMVF Y15 : REM set jog final velocity for homing
JOG ACC Z100 : REM set jog accel for homing
JOG DEC Z100 : REM set jog decel for homing
JOG VEL Z25 : REM set jog velocity for homing
JOG HOMVF Z5 : REM set jog final velocity for homing

REM X Axis settings
SET 16152 : REM Backup to edge is enabled
CLR 16153 : REM Backup to positive edge
CLR 16154 : REM set Final approach direction is positive

REM Yaxis settings
SET 16184 : REM Backup to edge is enabled
CLR 16185 : REM Backup to positive edge
SET 16186 : REM set Final approach direction is negative

REM Z Axis settings
SET 16216 : REM Backup to edge is enabled
SET 16217 : REM Backup to negative edge
SET 16218 : REM set Final approach direction is negative

REM Home Z Axis first
JOG HOME Z-1

REM Home Successful: BIT16198
REM Home Failed: BIT16199
WHILE (NOT BIT 16198)
IF (BIT 16199) THEN GOTO HomeFailed
WEND
REM Z is successful, home X and Y
JOG HOME X1 Y-1

REM X Home Successful: BIT16134
REM X Home Failed: BIT16135
REM Y Home Successful: BIT16166
REM Y Home Failed: BIT16167

```

## Parker Hannifin

```
WHILE (NOT BIT 16134 OR NOT BIT16166)
REM Jump to User error routine if home fails
IF (BIT 16135 OR BIT 16167) THEN GOTO HomeFailed
WEND

REM now find the Z markers for each axis encoder for
REM more accurate positioning
REM MSEEK uses master move profile settings

ACC 250
VEL 50
DEC 250
STP 250
JRK 1250

REM X axis ballscrew is 10mm per motor rev, so command a move
REM of 10.5 to ensure 1 rev
MSEEK X(10.5,0)
REM Rising First Marker : Z Mark, ENCO
REM Hardware Capture Parameter : P12292
REM Capture Complete Flag : BIT777

REM Y axis ballscrew is 10mm per motor rev, so command a move
REM of 10.5 to ensure 1 rev
MSEEK Y(10.5,0)
REM Rising First Marker : Z Mark, ENC1
REM Hardware Capture Parameter : P12548
REM Capture Complete Flag : BIT809

REM Z axis ballscrew is 5mm per motor rev, so command a move
REM of 5.5 to ensure 1 rev
MSEEK Z(5.5,0)
REM Rising First Marker : Z Mark, ENC2
REM Hardware Capture Parameter : P12804
REM Capture Complete Flag : BIT841

REM all position counters are now set to 0 by successful MSEEKs.
REM If home sensors/Z marks are not at the desired
REM machine zero location, move to "true zero"
REM or preload current location settings "RES X97 Y57.5 Z4.4"
X-97 Y-57.5 Z -4.4
INH -516 : REM wait until moves are complete
RES X Y Z : REM reset all counters to 0

REM change master move profile back to normal operation settings
ACC 750 VEL 250 DEC 750 STP 750 JRK 2250
REM change jog profiles back to normal operation settings

JOG ACC X1000 Y1000 Z200
JOG DEC X1000 Y1000 Z200
JOG VEL X300 Y300 Z100
RETURN : REM go back to main program execution

_ HomeFailed
IF (BIT 16199) THEN PRINT " Z Homing Failed"
IF (BIT 16135) THEN PRINT " X Homing Failed"
IF (BIT 16167) THEN PRINT " Y Homing Failed"

END

ENDP
```

# Open Sample

```

PROGRAM

CLEAR : REM Clear any variables dimension in program
DIM $V(1,10) : REM Dimensions one string variable of length 10

GOSUB OPENPORT : REM Go to SUBROUTINE OPENPORT

END

'SUBROUTINE OPENPORT
_OPENPORT

'Opens Ethernet Stream2
OPEN "STREAM3:" AS #1

'Continuous loop as long as "X" is not entered
_LOOP1

'Set String Variable 0 to nothing
$V0 = ""

PRINT #1, ""
PRINT #1, "What kind of fruit do you want?"
PRINT #1, "(A)pple, (B)anana, (C)occonut"
PRINT "I would like to have a";

'Infinite WHILE loop if they do not enter anything
WHILE ($V0 = "")
$V0 = UCASE$(INKEY$(1))
REM Stores Keyboard entry into String Variable 0
WEND

IF ($V0 = "A") THEN PRINT "n Apple"
REM If "A" was entered, then print n Apple
IF ($V0 = "B") THEN PRINT " Banana"
REM If "B" was entered, then print Banana
IF ($V0 = "C") THEN PRINT " Coconut"
REM If "C" was entered, then print Coconut
IF ($V0 = "X") THEN GOTO LOOP2
REM If "X" was entered, then goto LOOP2 to terminate program
IF ($V0 = CHR$(27)) THEN GOTO LOOP2
REM If "ESC key" was entered, then goto LOOP2 to terminate program

'Goes back to LOOP1
GOTO LOOP1

_LOOP2
PRINT #1, "Program terminated"
CLOSE #1
RETURN

ENDP

```



# Teach Array

```

PROGRAM

CLEAR : REM Clear out any variables dimensioned
DIM LV(2) : REM Dimension 2 Long Variables
DIM DA(1) : REM Dimension 1 Double Array
DIM $V(1,10) : REM Dimension 1 String Variable of length 10

'Go to SUBROUTINE Teach
GOSUB Teach

END

_Teach
RES X : REM Reset position to zero
DRIVE OFF X : REM DISABLE DRIVE, teach points by manually move motor.

'Start of InputPoints Routine
_InputPoints

'Print to the terminal "points to teach" and stores value into String
'Variable 0
INPUT; "Enter number of points to teach (value must greater than 0) = ";
$V0
'Stores the Value of String Variable 0 into Long Variable 1
LV1 = VAL($V0)

PRINT ""
PRINT LV1

'If Statement to check if value entered is correct
IF (LV1<=0)
  PRINT "ENTERED VALUE IS NOT VALID "; $V0
  PRINT "Value must be a number greater than 0"
  GOTO InputPoints
ENDIF

DIM DA0(LV1) : REM dimension array equal to number of points to teach

'use input 24 to tell controller to collect a teach point
'FOR/TO/STEP/NEXT loop to teach points into array
FOR LV0 = 0 TO (LV1-1) STEP 1
  PRINT "TURN MOTOR, THEN HIT INPUT 24 TO TEACH POINT"
  INH 24 : REM Inhibits the program until Input 24 is pressed
  DA0(LV0)=P12290/P12375 : REM Stores Double Array entry with Encoder
  Positive divide by PPU of Axis0
  INH -24 : REM Waits for Input 24 to turn off
NEXT

PRINT "Teach Completed, Total Points Taught = ";LV1
PRINT "Press Input 24 to enable drives and move to zero/start position "
INH 24
INH -24

DRIVE ON X : REM Enable Axis0 "X"
DWL 0.5
X0 : REM Moves to Zero Position
INH -516 : REM Waits for Motion to be completed
PRINT "Input 24 to run taught points"
INH 24

```

## Parker Hannifin

```
'FOR/TO/STEP/NEXT loop to make absolute moves to position taught
FOR LV0=0 TO (LV1-1) STEP 1
  X(DA0(LV0))
  INH -516
  PRINT DA0(LV0) : REM Print to terminal the Position it move to.
NEXT

RETURN

ENDP
```

# Binary Host Interface

---

You can enhance communications with the ACR series controller through the binary host interface.

## Binary Data Transfer

The binary data transfers in this chapter consist of a control character ( Header ID ) followed by a stream of data encoded according to the current state of the MODE command. Note that regardless of the mode, the Header ID is never converted during binary data transfer.

During binary transfers to the card, the delay between bytes must be no more than the communications timeout setting for the given channel. If the timeout activates, the transfer is thrown out and the channel goes back to waiting for a normal character or a binary header ID. The default communication timeout is 50 milliseconds.

The following is a list of valid data conversion modes. The default mode for the FIFO channel is zero and the default for the COM1 and COM2 channels is one. Note that high bit stripping cannot be done without also activating the control character-prefixing mode.

Mode	Description
MODE 0	No Conversion
MODE 1	Control Character Prefixing
MODE 2	No Conversion
MODE 3	Control Character Prefixing and High Bit Stripping

### *Control Character Prefixing*

Control character prefixing follows Kermit communications protocol conventions. The escape code for control character prefixing is the '#' character. The control character-prefixing mode prevents valid data within a binary packet from being confused with the serial XON / XOFF flow control codes.

### **Transmitting**

If the character to be sent is either a 0x7F or a character in the range of 0x00 to 0x1F, the character is 'XORed' with 0x40 and preceded with a '#' character. Otherwise, the byte is sent normally.

For example, if the character to be sent is 0x01, the character is transmitted as a "#A" string. ( 0x01 XOR 0x40 = 0x41 = 'A' ) The special case where the character to be sent is the '#' character is handled with the two character "##" string.

## Receiving

When receiving control prefix encoded data, a '#' character is thrown away and causes the next character to be read from the data stream. If the character is in the range of 0x3F to 0x5F, the character is 'XORed' with 0x40 to decode the true value. Otherwise, the character is used exactly as read from the stream.

## *High Bit Stripping*

High bit stripping follows Kermit communications protocol conventions for 7-bit data paths. The escape code for high bit stripping is the '&' character and must be used in conjunction with the control character prefixing described above.

High bit stripping is for cases in which a 7-bit data path must be used for binary data transfer. This mode introduces a large overhead in the transfer of binary data since over half of the bytes are expanded to two byte sequences and several are expanded to three bytes. If possible, an 8-bit data path should be used for binary data transfer.

## Transmitting

If the character to be sent is greater than 0x7F, the character is 'ANDed' with 0x7F and proceeded with the '&' character. Note that the AND may result in a control code which must then handled by control character prefixing. The original character may also need to be sent with control character prefixing.

For example, if the character to be sent is 0xC2, the character is transmitted as a "&B" string. (  $0xC2 \text{ AND } 0x7F = 0x42 = 'B'$  ) As another example, if character to be sent is 0x83, the character is transmitted as the three character "&#C" string. (  $0x83 \text{ AND } 0x7F = 0x03$  (control character) ) The special case where the character to be sent is the '&' character is handled with the two character "#&" string.

## Receiving

When receiving high bit encoded data, '#' characters are handled as normal control character prefix sequences. If the received character is neither a '#' nor a '&' character, the character is used exactly as read from the stream.

If the received character is the '&' character, it is thrown away and causes the next character to be read from the data stream. This new character may be a '#' character, which will initiate control prefix decoding sequence. The result is a value in the range of 0x00 to 0x7F, which is then 'ORed' with 0x80 to re-establish the high bit in the data.

## Binary Data Packets

Packets allow binary access to system parameters at any time. This method must be used if commands are sitting in the input queue since **PRINT** statements would also be buffered. The packet is the quickest way to access information such as current position and following error for display in an application program.

### *Packet Request*

Packets are requested by sending a four-byte binary request record. The following is a list of the bytes contained in this record:

Data Field	Description
Byte 0	Header ID ( 0x00 )
Byte 1	Group Code
Byte 2	Group Index
Byte 3	Isolation Mask

### *Group Code and Index*

The group code and group index work as a pair to select the data coming back in a data packet. The group code selects a general data grouping and the group index selects a set of eight fields within that group. The isolation mask then selects which of these eight fields is to compose the final data packet.

### *Isolation Mask*

The isolation mask acts as a filter to select only the specific data required (for example, actual position for AXIS 2, AXIS 3 and AXIS 5.) If a bit is set in this mask, the corresponding data field is allowed to return in the data packet. In order to return all eight fields, the isolation mask must be 0xFF. Mask Bit0 is used to isolate the first field in a group and Bit7 is used to isolate the last field.

## Parameter Access

The following is a list of groups and what the isolation mask will isolate:

Group	Description	Isolation Usage
0x10	Flag Parameters	Eight consecutive parameters
0x18	Encoder Parameters	ENC0 - ENC15
0x19	DAC parameters	DAC0 - DAC7
0x1A	PLC parameters	PLC0 - PLC7
0x1B	Miscellaneous	Eight consecutive parameters
0x1C	Program Parameters	PROG0 - PROG15
0x20	Master Parameters	MASTER0 - MASTER7
0x28	Master Parameters	MASTER8 - MASTER15
0x30	Axis Parameters	AXIS0 - AXIS7
0x38	Axis Parameters	AXIS8 - AXIS15
0x40	CMT Parameters	CMT0 - CMT7
0x50	Logging Parameters	Eight consecutive parameters
0x60	Encoder Parameters	ENC16 - ENC23

## Packet Retrieval

### Packet Header

After a packet request is received, the ACR2000/ACR8000/ACR8010 responds by sending back a four-byte packet header. This header is a direct echo of the request record. The echoing allows host software to do asynchronous sampling. A request can be sent by one part of the program and packet retrieval can be done by a centralized receiver. This routine would recognize the 0x00 in the header as an incoming packet and act accordingly.

In a synchronous retrieval mode, it is possible for extra data to be in front of an incoming packet header. This would occur if there is any ASCII data pending at the time of the request, such as during a LIST. In order to retrieve a packet correctly, the host software must be able to process this data while waiting for the packet header to arrive. This should not be a problem, however, if all system echoing is turned off and no ASCII data retrieval is being done.

### Packet Data

After the packet header is received, the data arrives as a set of four byte fields. The bits in the isolation mask determine the number of fields and what they apply to. If the mask is 0xFF, a total of eight fields (32 bytes) would follow. The first field to be returned corresponds to the bit position of the lowest bit in the mask that is set.

Long integers (LONG) are returned as a four-byte field. Floating point numbers (FP32) are returned in 32-bit IEEE floating-point format. Both types of field are returned with the low order byte first.

### Usage Example

This example requests actual positions from axis 2, 3 and 5:

Fields:	Header	Axis2	Axis3	Axis5
<b>Output:</b>	00 30 02 2C			
<b>Input:</b>	00 30 02 2C	20 21 22 23	30 31 32 33	50 51 52 53

Actual Positions:

AXIS2: 0x23222120  
 AXIS3: 0x33323130  
 AXIS5: 0x53525150

## Binary Parameter Access

Binary parameter access provides a method of reading from and writing to single system parameters on the card. Unlike binary data packets, binary parameter access uses the index of the parameter directly from Appendix A. There are no groups or masks.

A parameter access header consists of a Header ID ( 0x00 ) followed by a Packet ID code and a 2-byte parameter index. The Packet ID codes for the different types of packets are shown below. The following pages define each of the packets in detail.

### Packet ID Codes

Code	Packet Type	Description
0x88	Binary Get Long	Receive long integer from card
0x89	Binary Set Long	Send long integer to card
0x8A	Binary Get IEEE	Receive IEEE value from card
0x8B	Binary Set IEEE	Send IEEE value to card

## Usage Example

This example requests current position from axis 0 parameter P12288:

Fields:	Header	Parameter Value
<b>Output:</b>	00 88 00 30	
<b>Input:</b>	00 88 00 30	10 11 12 00

Current Position Parameter Value:

AXIS0: 0x00121110

## Binary Get Long

This packet gets a single parameter from the card. The parameter index is a 2-byte value sent low-order byte first. The parameter value in the receive packet is a 4-byte long integer received low-order byte first.

### Transmit Packet

Data Field	Data Type	Description
Byte 0	BYTE	Header ID ( 0x00 )
Byte 1	BYTE	Packet ID ( 0x88 )
Byte 2-3	WORD	Parameter Index

### Receive Packet

Data Field	Data Type	Description
Byte 0	BYTE	Header ID ( 0x00 )
Byte 1	BYTE	Packet ID ( 0x88 )
Byte 2-3	WORD	Parameter Index
Byte 4-7	LONG	Parameter Value

## Binary Set Long

This packet sets a single parameter on the card. The parameter index is a 2-byte value sent low-order byte first. The parameter value is a 4-byte long integer and is sent low order byte first.

### Transmit Packet

Data Field	Data Type	Description
Byte 0	BYTE	Header ID ( 0x00 )
Byte 1	BYTE	Packet ID ( 0x89 )
Byte 2-3	WORD	Parameter Index
Byte 4-7	LONG	Parameter Value



## Receive Packet

None.

### *Binary Get IEEE*

This packet gets a single parameter from the card. The parameter index is a 2-byte value sent low-order byte first. The parameter value in the receive packet is a 4-byte image of an IEEE floating point number received low-order byte first.

## Transmit Packet

Data Field	Data Type	Description
Byte 0	BYTE	Header ID ( 0x00 )
Byte 1	BYTE	Packet ID ( 0x8A )
Byte 2-3	WORD	Parameter Index

## Receive Packet

Data Field	Data Type	Description
Byte 0	BYTE	Header ID ( 0x00 )
Byte 1	BYTE	Packet ID ( 0x8A )
Byte 2-3	WORD	Parameter Index
Byte 4-7	IEEE32	Parameter Value

### *Binary Set IEEE*

This packet sets a single parameter on the card. The parameter index is a 2-byte value sent low-order byte first. The parameter value is a 4-byte image of an IEEE floating point number and is sent low-order byte first.

## Transmit Packet

Data Field	Data Type	Description
Byte 0	BYTE	Header ID ( 0x00 )
Byte 1	BYTE	Packet ID ( 0x8B )
Byte 2-3	WORD	Parameter Index
Byte 4-7	IEEE32	Parameter Value

## Receive Packet

None.

## Binary Peek Command

A binary peek command consists of a four-byte header followed by an address and the data to be fetched from that address. The header contains a data conversion code that controls pointer incrementing and the FP32 -> IEEE floating point conversion.

**Note:** Refer to Binary Global Parameter Access [Note](#) at end of Binary Host Interface section for details.

The command returns the header and peek address followed by the requested data.

### *Binary Peek Packet*

#### Transmit Packet

Data Field	Description
Byte 0	Header ID ( 0x00 )
Byte 1	Packet ID ( 0x90 )
Byte 2	Conversion Code
Byte 3	Peek Word Count
Long 0	Peek Address

#### Receive Packet

Data Field	Description
Byte 0	Header ID ( 0x00 )
Byte 1	Packet ID ( 0x90 )
Byte 2	Conversion Code
Byte 3	Peek Word Count
Long 0	Peek Address
Long 1	Peek Data 0
Long 2	Peek Data 1
:	
Long N	Peek Data ( Count - 1 )

#### Conversion Codes

Code	Source	Destination
0x00	LONG	LONG
0x01	FP64	IEEE32
0x02	FP32	IEEE32

## Usage Example

**NOTE:** Addresses shown are for example only. Addresses will vary from card to card, depending on system memory allocation.

This example peeks at three words, starting at peek address 0x404500:

Fields:	Header	Address	Data0	Data1	Data2
<b>Output:</b>	00 90 00 03	00 50 40 00			
<b>Input:</b>	00 90 00 03	00 50 40 00	10 11 12 13	20 21 22 23	30 31 32 33

Requested data at address:

0x405000:0x13121110

0x405001:0x23222120

0x405002:0x33323130

## Binary Poke Command

A binary poke command consists of a four-byte header followed by an address and the data to be stored at that address. There is no information returned from this command. The header contains a data conversion code that controls pointer incrementing and the IEEE ->FP32 floating point conversion.

**NOTE:** Refer to Binary Global Parameter Access [Note](#) at end of Binary Host Interface section for details.

### *Binary Poke Packet*

#### Transmit Packet

Data Field	Description
Byte 0	Header ID ( 0x00 )
Byte 1	Packet ID ( 0x91 )
Byte 2	Conversion Code
Byte 3	Poke Word Count
Long 0	Poke Address
Long 1	Poke Data 0
Long 2	Poke Data 1
:	
Long N	Poke Data ( Count - 1 )

## Receive Packet

None.

## Conversion Codes

Code	Source	Destination
0x00	LONG	LONG
0x01	IEEE32	FP64
0x02	IEEE32	FP32

## Usage Example

**NOTE:** Addresses shown are for example only. Addresses will vary from card to card, depending on system memory allocation.

This example pokes data into three words, starting at poke address 0x405000:

Fields:	Header	Address	Data0	Data1	Data2
<b>Output:</b>	00 91 00 03	00 50 40 00	10 11 12 13	20 21 22 23	30 31 32 33

Data poked into addresses:

0x405000:0x13121110

0x405001:0x23222120

0x405002:0x33323130

## Binary Address Command

A binary address command consists of a four-byte header containing a program number and a parameter code. The command returns the header followed by the base address of the parameter type in question. If the returned address is zero, no parameters of that type have been allocated in the given program.

Peeking at the returned address will return the number of variables dimensioned for the requested type. In the case of numeric variables, (DV,SV,LV) the count will be followed by the actual numeric data. For arrays, (DA, SA, LA) the count will be followed by the addresses of the individual arrays. These addresses point to storage areas as if they were normal numeric variables of the same type (count followed by data.)

## Binary Address Packet

### Transmit Packet

Data Field	Description
Byte 0	Header ID ( 0x00 )
Byte 1	Packet ID ( 0x92 )
Byte 2	Program Number
Byte 3	Parameter Code

### Receive Packet

Data Field	Description
Byte 0	Header ID ( 0x00 )
Byte 1	Packet ID ( 0x92 )
Byte 2	Program Number
Byte 3	Parameter Code
Long 0	Parameter Address

### Parameter Codes

Code	Mnemonic	Description
0x00	DV	Double Variables
0x01	DA	Double Arrays
0x02	SV	Single Variables
0x03	SA	Single Arrays
0x04	LV	Long Variables
0x05	LA	Long Arrays
0x06	\$V	String Variables
0x07	\$A	String Arrays

### Usage Example

**NOTE:** Addresses shown are for example only. Addresses will vary from card to card, depending on system memory allocation.

This example requests the starting address of the Single Variable information for Program 5:

Fields:	Header	Parameter Address
---------	--------	-------------------

**Output:** 00 92 05 02

**Input:** 00 92 05 02 00 80 40 00

Starting address of the Single Variable information for Program 5:

Address: 0x408000

# Binary Parameter Address Command

A binary parameter address command consists of a four-byte header containing a parameter index. The command returns the header followed by the address of the parameter. If the returned address is zero, the parameter index was invalid.

## Binary Address Packet

### Transmit Packet

Data Field	Data Type	Description
Byte 0	BYTE	Header ID ( 0x00 )
Byte 1	BYTE	Packet ID ( 0x93 )
Byte 2-3	WORD	Parameter Index

### Receive Packet

Data Field	Data Type	Description
Byte 0	BYTE	Header ID ( 0x00 )
Byte 1	BYTE	Packet ID ( 0x93 )
Byte 2-3	WORD	Parameter Index
Long 0	LONG	Parameter Address

## Usage Example

**NOTE:** Addresses shown are for example only. Addresses will vary from card to card, depending on system memory allocation.

This example requests the address of the axis 0 current position parameter:

Fields:	Header	Parameter Address
<b>Output:</b>	00 93 00 30	
<b>Input:</b>	00 93 00 30	31 50 40 00

Current Position Parameter Address:

AXIS0: 0x405031

# Binary Mask Command

A binary mask command consists of a four-byte header followed by an address and two bit masks to be combined with the data at that address. There is no information returned from this command. The address must point to a long integer storage area. The NAND mask is used to clear bits and the OR mask is used to set bits. The data is modified as follows:

$$\text{data} = (\text{data AND NOT nandmask}) \text{ OR ormask}$$

## Binary Mask Packet

### Transmit Packet

Data Field	Data Type	Description
Byte 0	BYTE	Header ID ( 0x00 )
Byte 1	BYTE	Packet ID ( 0x94 )
Byte 2	BYTE	Reserved ( 0x00 )
Byte 3	BYTE	Reserved ( 0x00 )
Long 0	BYTE	Data Address
Long 1	BYTE	NAND Mask
Long 2	BYTE	OR Mask

### Receive Packet

None.

## Usage Example

**NOTE:** Addresses shown are for example only. Addresses will vary from card to card, depending on system memory allocation.

This example uses the Binary Mask Command to clear all of the Opto-isolated Outputs and then set Output 32. The data address for Opto-isolated Outputs Parameter P4097 is assumed to have been previously returned using the Binary Parameter Address Command on the previous page.

Fields:	Header	Parameter Address	NAND Mask	OR Mask
<b>Output:</b>	00 94 00 00	43 60 40 00	FF FF FF FF	01 00 00 00

Opto-isolated Output Parameter P4097 Modified Data at address:  
0x406043:0x00000001

# Binary Parameter Mask Command

A binary parameter mask command consists of a four-byte header followed by two bit masks to be combined with a system parameter. There is no information returned from this command. The parameter index in the header must be a long integer. The NAND mask is used to clear bits and the OR mask is used to set bits. The data is modified as follows:

$$\text{data} = (\text{data AND NOT nandmask}) \text{ OR ormask}$$

## Binary Mask Packet

### Transmit Packet

Data Field	Data Type	Description
Byte 0	BYTE	Header ID ( 0x00 )
Byte 1	BYTE	Packet ID ( 0x95 )
Byte 2-3	WORD	Parameter Index
Long 0	LONG	NAND Mask
Long 1	LONG	OR Mask

### Receive Packet

None.

## Usage Example

This example uses the Binary Parameter Mask Command to clear all of the Opto-isolated Outputs and then set Output 32.

<b>Fields:</b>	Header	NAND Mask	OR Mask
<b>Output:</b>	00 95 01 10	FF FF FF FF	01 00 00 00

Opto-isolated Output Parameter P4097 Modified Data:

P4097: 0x00000001



## Binary Move Command

A binary move consists of a variable length header followed by a number of four-byte data fields. The bit-mapped information in the header determines the number of data fields and their content. All data fields are sent low order byte first.

### Binary Move Packet

Data Field	Data Type	Description
Head 00	BYTE	Header ID (0x04)
Head 01	BYTE	Header Code 0
Head 02	BYTE	Header Code 1
Head 03	BYTE	Header Code 2
Head 04	BYTE	Header Code 3
Head 05	BYTE	Header Code 4
Head 06	BYTE	Header Code 5
Head 07	BYTE	Header Code 6
Head 08	BYTE	Header Code 7
Data 00	IEEE32	Master <b>VEL</b>
Data 01	IEEE32	Master <b>FVEL</b>
Data 02	IEEE32	Master <b>ACC/DEC</b>
Data 03	LONG*	Slave 0 Target or NURB/Spline control point
Data 04	LONG*	Slave 1 Target or NURB/Spline control point
Data 05	LONG*	Slave 2 Target or NURB/Spline control point
Data 06	LONG*	Slave 3 Target or NURB/Spline control point
Data 07	LONG*	Slave 4 Target or NURB/Spline control point
Data 08	LONG*	Slave 5 Target or NURB/Spline control point
Data 09	LONG*	Slave 6 Target or NURB/Spline control point
Data 10	LONG*	Slave 7 Target or NURB/Spline control point
Data 11	LONG*	Slave 8 Target or NURB/Spline control point
Data 12	LONG*	Slave 9 Target or NURB/Spline control point
Data 13	LONG*	Slave 10 Target or NURB/Spline control point
Data 14	LONG*	Slave 11 Target or NURB/Spline control point
Data 15	LONG*	Slave 12 Target or NURB/Spline control point
Data 16	LONG*	Slave 13 Target or NURB/Spline control point
Data 17	LONG*	Slave 14 Target or NURB/Spline control point
Data 18	LONG*	Slave 15 Target or NURB/Spline control point
Data 19	LONG*	Primary Center
Data 20	LONG*	Secondary Center
Data 21	IEEE32	Primary Scaling or NURB/Spline Knot
Data 22	IEEE32	Secondary Scaling or NURB Weight

\* These fields are in IEEE32 format if bit 2 of header code 3 is set

There are two versions defined for Header Code 0 based on Secondary Master Flag Bit Index 5, Enable Rapid Move Modes.

The default-disabled mode for this flag (Secondary Master Flag Bit Index 5 cleared) uses the following Header Code 0 definition. This Header Code 0 definition is compatible with ACR2000/ACR8000 Firmware Versions 1.17.04 and below, and is compatible with all AcroCut/AcroMill software versions.

## Header Code 0

Enable Rapid Move Modes flag disabled—default cleared value:

Data Field	Data Type	Description
Bit 0	<b>FVEL</b> Lockout	Forces <b>FVEL</b> to zero for this move
Bit 1	<b>FOV</b> Lockout	Forces <b>FOV</b> to 1.0 for this move
Bit 2	<b>STP</b> Ramp Activate	Sets <b>STP</b> equal to <b>DEC</b> , else <b>STP 0</b>
Bit 3	Code 3 Present	Header contains "Header Code 3"
Bit 4	Velocity Data Present	Packet contains master <b>VEL</b>
Bit 5	Acceleration Data Present	Packet contains master <b>ACC/DEC</b>
Bit 6	Counter Dir	Count down if set, else up
Bit 7	Counter Mode	Master move counter enable

The enabled mode for this flag (Secondary Master Flag Bit Index 5 Set) uses the following Header Code 0 definition. This Header Code 0 definition is compatible with ACR2000/ACR8000/ACR8010 Firmware Versions 1.17.05 and above, and is not compatible with AcroCut/AcroMill Software Versions 1.15.00 and below. The Move Modes for this header code are defined following the header code definitions.

## Header Code 0

Enable Rapid Move Modes flag enabled—set value:

Data Field	Data Type	Description
Bit 0	Move Mode Bit 1	Selects the move mode for this move along with Header Code 0 Bit 2.
Bit 1	<b>FOV/ROV</b> Lockout	Forces <b>FOV</b> or <b>ROV</b> to 1.0 for this move
Bit 2	Move Mode Bit 0	Selects the move mode for this move along with Header Code Bit 0.
Bit 3	Code 3 Present	Header contains "Header Code 3"
Bit 4	Velocity Data Present	Packet contains master <b>VEL</b>
Bit 5	Acceleration Data Present	Packet contains master <b>ACC/DEC</b>
Bit 6	Counter Dir	Count down if set, else up
Bit 7	Counter Mode	Master move counter enable

### Header Code 1

Data Field	Data Type	Description
Bit 0	Master Bit 0	Master for this move packet
Bit 1	Master Bit 1	
Bit 2	Master Bit 2	
Bit 3	Interrupt Select	Interrupt host when move starts
Bit 4	Arc Direction	CCW if set, else CW
Bit 5	Arc Mode	Packet contains center points or Spline Knot present
Bit 6	Arc Plane Bit 0	Primary and secondary axis or <b>NURB</b> Mode
Bit 7	Arc Plane Bit 1	For binary arc move commands or <b>SPLINE</b> Mode

### Header Code 2

Data Field	Data Type	Description
Bit 0	Slave 0 Present	Slave target positions to be contained in this move packet
Bit 1	Slave 1 Present	
Bit 2	Slave 2 Present	
Bit 3	Slave 3 Present	
Bit 4	Slave 4 Present	
Bit 5	Slave 5 Present	
Bit 6	Slave 6 Present	
Bit 7	Slave 7 Present	

### Header Code 3

Data Field	Data Type	Description
Bit 0	Incremental Target	Target positions are incremental
Bit 1	Incremental Center	Center points are incremental
Bit 2	Floating Point Data	Targets and centers are IEEE32
Bit 3	Arc Radius Scaling	Packet contains radius scaling / NURB/Spline
Bit 4	FVEL Data Present	Packet contains master <b>FVEL</b>
Bit 5	Block Skip Check	Sets the master Block Skip Check
Bit 6	NURB or Spline	Move data packet for <b>NURB</b> or Spline Interpolation
Bit 7	Extended Codes	Extended codes 4,5,6 and 7 are present. This bit should be set if DBCB is used

### Header Code 4

Data Field	Data Type	Description
Bit 0	Reserved	Reserved
Bit 1		
Bit 2		
Bit 3	Master Bit 3	Master for this move packet
Bit 4	Reserved	Reserved
Bit 5		
Bit 6		
Bit 7		

### Header Code 5

Data Field	Data Type	Description
Bit 0	Reserved	Reserved
Bit 1		
Bit 2		
Bit 3		
Bit 4		
Bit 5		
Bit 6		
Bit 7		

### Header Code 6

Data Field	Data Type	Description
Bit 0	Slave 8 Present	Slave target positions to be contained in this move packet
Bit 1	Slave 9 Present	
Bit 2	Slave 10 Present	
Bit 3	Slave 11 Present	
Bit 4	Slave 12 Present	
Bit 5	Slave 13 Present	
Bit 6	Slave 14 Present	
Bit 7	Slave 15 Present	

## Header Code 7

Data Field	Data Type	Description
Bit 0	Reserved	Reserved
Bit 1		
Bit 2		
Bit 3		
Bit 4		
Bit 5		
Bit 6		
Bit 7		

The following Move Modes definition applies to Header Code 0 used with the Master Enable Rapid Move Modes flag set.

## Move Modes

Bits 0 and 2 in Header Code 0 indicate which type of move mode is contained in the binary move packet as follows:

Bit 1 (Header Code 0 Bit 0)	Bit 0 (Header Code 0 Bit 2)	Move Mode
0	0	Move Mode 0 - Feed Continuous
0	1	Move Mode 1 - Feed Cornering
1	0	Move Mode 2 - Feed Stopping
1	1	Move Mode 3 - Rapid

Where: 0 = Bit Cleared; 1 = Bit Set

### Example 1

The following illustrates Move Mode 0—Feed Continuous:

#### Move Mode 0—Feed Continuous

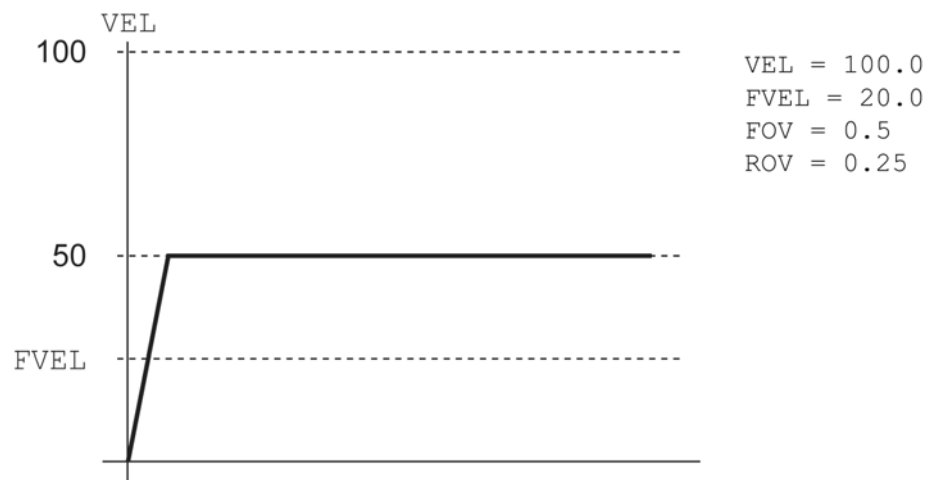

### Example 2

The following illustrates Move Mode 1—Feed Cornering:

#### Move Mode 1—Feed Cornering

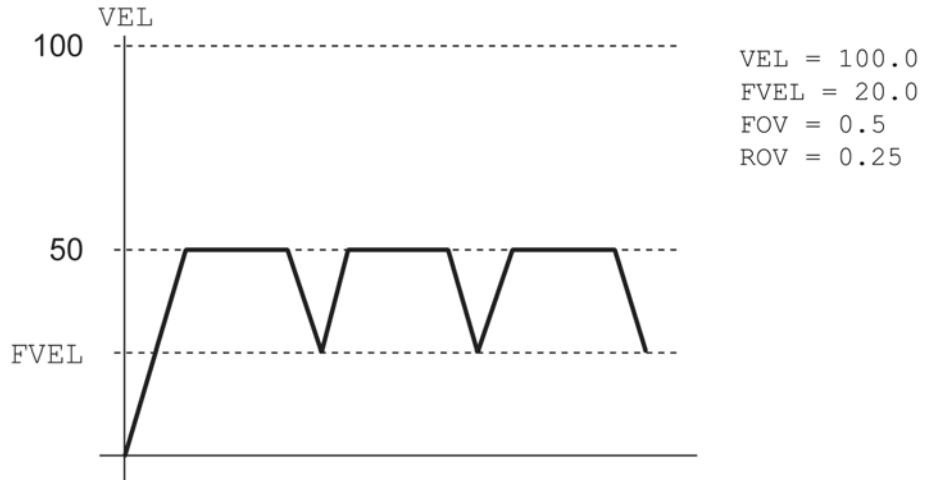

### Example 3

The following illustrates Move Mode 2—Feed Stopping:

#### Move Mode 2—Feed Stopping

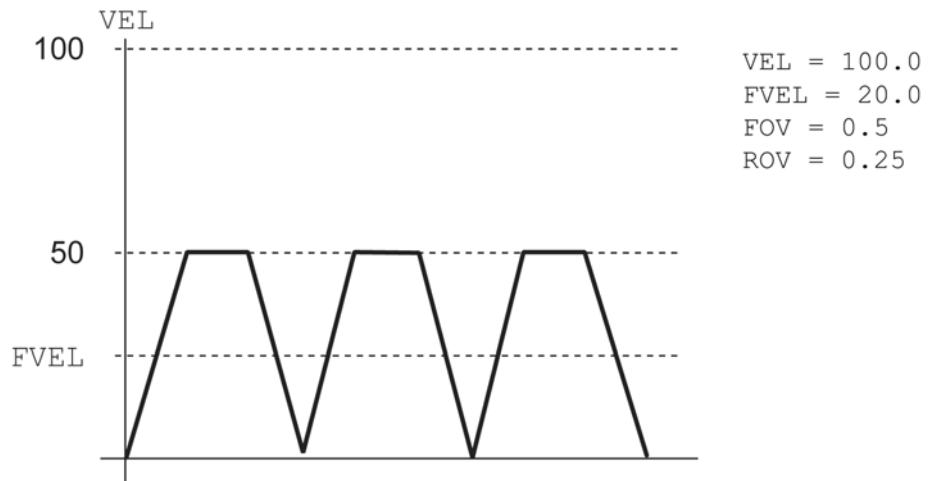

### Example 4

The following illustrates Move Mode 3—Rapid:

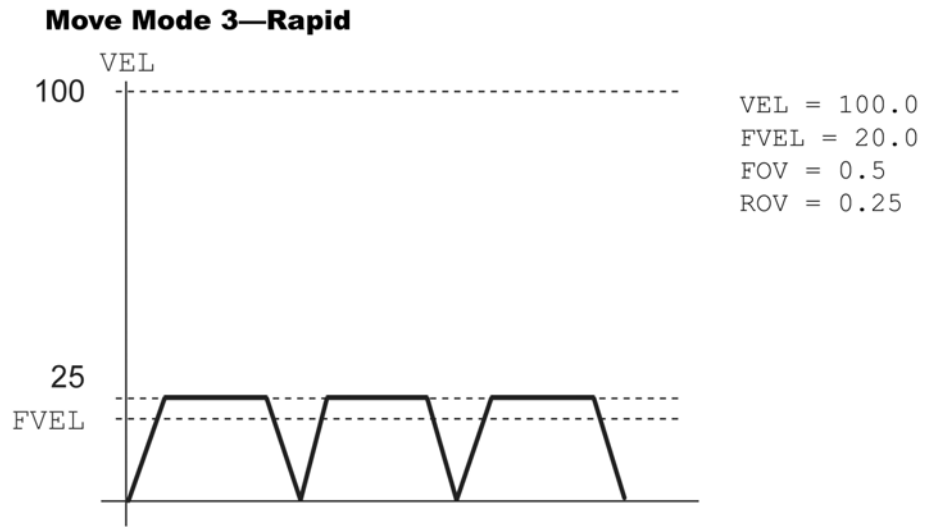

### Linear Moves

The bits in header code 2 indicate which target positions are contained in the binary move packet. If the "incremental target" bit in header code 3 is set, the targets are relative to the current target positions of the slaves; otherwise, the targets are absolute. The "floating point data" bit in header code 3 indicates that the target data is in IEEE floating point format, otherwise they are long integers.

### Arc Moves

When the "arc mode" bit in header code 1 is set, a circular arc is generated using two of the first three slaves attached to a master. Any slaves that are given a target position, but are not part of the circular interpolation, are executed as normal linear moves. This allows for helical interpolation.

The "arc plane" bits in header code 1 are combined to generate a number from 0 to 3 that defines the primary and secondary axes for the arc as follows:

Arc Plane	Primary Axis	Secondary Axis
0	Slave 0	Slave 1
1	Slave 1	Slave 2
2	Slave 2	Slave 0
3	Reserved	Reserved

The "arc direction" bit in header code 1 indicates the direction of the arc relative to the primary and secondary axes. A counter-clockwise arc is defined as an arc from the positive primary axis toward the positive secondary axis.

The radius of the arc will be equal to the distance between the arc target position and the given center point. If the arc target position is equal to the target position of the previous move, a 360-degree path will be generated. The target position of the previous move must lie on the defined arc or the axes will jump to that location before the arc begins.

If the "incremental center" bit in header code 3 is set, the center points are relative to the current target positions of the slaves, otherwise the center points are absolute. The "floating point data" bit in header code 3 indicates that the given center points are in IEEE floating point format, otherwise they are long integers.

### *NURB or SPLINE Moves*

When the "NURB or Spline" bit in header code 3 (Bit 6) is set, the move data packet includes NURB or Spline curve data. In addition, bit 5 and 6 in header code 1 will differentiate if the data is NURB or Spline. Bit 5 of header code 1 is set when Spline data includes Knots.

The control points for NURB and Spline are sent as DATA3 thru DATA10, similar to the way the normal slave targets are sent. Load the Knot in DATA13 and Weight in DATA14 and set the Bit 3 of code 3.

## Binary SET and CLR

The immediate setting and clearing of bits can be accomplished with a 3-byte binary command sequence. This sequence is a 1-byte command header followed by a two-byte index value. The index value is sent low order byte first. The command is not queued and the set or clear occurs when the command is first seen by the board.

### *Binary SET*

Data Type	Description
Byte 0	Header ID ( 0x1C )
Byte 1	Index Byte 0
Byte 2	Index Byte 1
Byte 3	0x00, this byte is for ACR8020 DPCB only.



## Binary CLR

Data Type	Description
Byte 0	Header ID ( 0x1D )
Byte 1	Index Byte 0
Byte 2	Index Byte 1
Byte 3	0x00, this byte is for ACR8020 DPCB only.

## Usage Example

Binary Output	Description
1C 08 02	Set bit 520 ( 0x0208 )
1D 20 00	Clear bit 32 ( 0x0010 )

## Binary FOV Command

The immediate setting of feedrate override for any or all axes can be accomplished with an 8-byte binary command sequence. This sequence is a 4-byte command header followed by a 4-byte **FOV** value. The command is not queued and the **FOV** occurs when the command is first seen by the board.

The second byte in the header is a bit mask that determines which masters are affected by the **FOV** value that follows. The **FOV** value is an image of an IEEE 32-bit floating-point value, sent low order byte first.

For more than eight masters the header bit mask Byte 1 should be set zero, and then the two optional 16 master header bit mask Byte 2 and Byte 3 should be filled accordingly.

## Binary Format

Data Type	Description
Byte 0	Header ID ( 0x07 )
Byte 1	Header Bit Mask
Byte 2	16 Master Header Bit Mask, Part 1
Byte 3	16 Master Header Bit Mask, Part 2
Byte 4	<b>FOV</b> Byte 0
Byte 5	<b>FOV</b> Byte 1
Byte 6	<b>FOV</b> Byte 2
Byte 7	<b>FOV</b> Byte 3

## Header Bit Mask

Data Type	Description
Bit 0	Master 0 Affected
Bit 1	Master 1 Affected
Bit 2	Master 2 Affected
Bit 3	Master 3 Affected
Bit 4	Master 4 Affected
Bit 5	Master 5 Affected
Bit 6	Master 6 Affected
Bit 7	Master 7 Affected

**NOTE:** Masters affected by the **FOV** contained in this command.

## 16 Master Header Bit Mask, Part 1

Data Type	Description
Bit 0	Master 0 Affected
Bit 1	Master 1 Affected
Bit 2	Master 2 Affected
Bit 3	Master 3 Affected
Bit 4	Master 4 Affected
Bit 5	Master 5 Affected
Bit 6	Master 6 Affected
Bit 7	Master 7 Affected

**NOTE:** Masters affected by the **FOV** contained in this command.

## 16 Master Header Bit Mask, Part 2

Data Type	Description
Bit 8	Master 8 Affected
Bit 9	Master 9 Affected
Bit 10	Master 10 Affected
Bit 11	Master 11 Affected
Bit 12	Master 12 Affected
Bit 13	Master 13 Affected
Bit 14	Master 14 Affected
Bit 15	Master 15 Affected

**NOTE:** Masters affected by the **FOV** contained in this command.

## Usage Example

This example uses the following IEEE conversions:

0.500 = 3F000000

0.123 = 3DFBE76D

Binary Output	Description
07 08 00 00 00 00 00 3F	Set Master 3 FOV to 0.5
07 05 00 00 6D E7 FB 3D	Set Master 0 and Master 2 FOV to 0.123

## Binary ROV Command

(Version 1.17.05 & Up)

The immediate setting of rapid feedrate override for any or all axes can be accomplished with an 8-byte binary command sequence. This sequence is a 4-byte command header followed by a 4-byte **ROV** value. The command is not queued and the **ROV** occurs when the command is first seen by the board.

The second byte in the header is a bit mask that determines which masters are affected by the **ROV** value that follows. The **ROV** value is an image of an IEEE 32-bit floating-point value, sent low order byte first.

For more than eight masters the header bit mask Byte 1 should be set zero, and then the two optional 16 master header bit mask Byte 2 and Byte 3 should be filled accordingly.

### Binary Format

Data Type	Description
Byte 0	Header ID ( 0x1F )
Byte 1	Header Bit Mask
Byte 2	16 Master Header Bit Mask, Part 1
Byte 3	16 Master Header Bit Mask, Part 2
Byte 4	<b>ROV</b> Byte 0
Byte 5	<b>ROV</b> Byte 1
Byte 6	<b>ROV</b> Byte 2
Byte 7	<b>ROV</b> Byte 3

## Header Bit Mask

Data Type	Description
Bit 0	Master 0 Affected
Bit 1	Master 1 Affected
Bit 2	Master 2 Affected
Bit 3	Master 3 Affected
Bit 4	Master 4 Affected
Bit 5	Master 5 Affected
Bit 6	Master 6 Affected
Bit 7	Master 7 Affected

**NOTE:** Masters affected by the **ROV** contained in this command.

## 16 Master Header Bit Mask, Part 1

Data Type	Description
Bit 0	Master 0 Affected
Bit 1	Master 1 Affected
Bit 2	Master 2 Affected
Bit 3	Master 3 Affected
Bit 4	Master 4 Affected
Bit 5	Master 5 Affected
Bit 6	Master 6 Affected
Bit 7	Master 7 Affected

**NOTE:** Masters affected by the **ROV** contained in this command.

## 16 Master Header Bit Mask, Part 2

Data Type	Description
Bit 8	Master 8 Affected
Bit 9	Master 9 Affected
Bit 10	Master 10 Affected
Bit 11	Master 11 Affected
Bit 12	Master 12 Affected
Bit 13	Master 13 Affected
Bit 14	Master 14 Affected
Bit 15	Master 15 Affected

**NOTE:** Masters affected by the **ROV** contained in this command.

## Usage Example

This example uses the following IEEE conversions:

0.500 = 3F000000

0.123 = 3DFBE76D

Binary Output	Description
07 08 00 00 00 00 00 3F	Set Master 3 ROV to 0.5
07 05 00 00 6D E7 FB 3D	Set Master 0 and Master 2 ROV to 0.123

## Application: Binary Global Parameter Access

Also see [Binary Peek](#) and [Binary Poke](#) commands.

### Description

Global user variables (see Variable Memory Allocation) can be read and set using the Binary Peek and Poke Command interface.

**NOTE:** A maximum word count of 255 can be used when using the Binary Peek and Poke Command interface.

### System Pointer Address (hardware dependent)

Controller	System Pointer Address
ACR1200	0x400008
ACR1500	0xC08008
ACR2000	0x400008
ACR8000	0x403E08
ACR8010	0x403E08
ACR8020	0x400009

### Reading Global Variables

Peek at the System Pointer Address (see above information) to receive the Global\_Variable\_Address.

- If the returned address is zero, there are no dimensioned global variables (see the **DIM** command).
- If the returned address is other than zero, peek at this address to receive the number of dimensioned global variables.

Read a global variable P(index) using the following addressing scheme for Peek:

- Peek address = Global\_Variable\_Address + 1 + ( index \* 2 )
- Where index = 0 to ( no. of dimensioned global variables - 1 )

Even though global variables are stored on-board as floating point 64 (FP64) numbers, they are returned as IEEE32 numbers (Conversion Code 0x01).

### *Setting Global Variables*

Peek at the System Pointer Address (see System Pointer Address on previous page) to receive the Global\_Variable\_Address.

- If the returned address is zero, there are no dimensioned global variables (see the DIM command).
- If the returned address is other than zero, peek at this address to receive the number of dimensioned global variables.

To prevent corruption of user memory, always verify P(index) is within the dimensioned global variable range before performing a POKE command.

Set a global variable P(index) using the following addressing scheme for Poke:

- $\text{Poke address} = \text{Global Variable Address} + 1 + (\text{index} * 2)$   
Where index = 0 to ( number of dimensioned global variables - 1 )

Even though global variables are sent as IEEE32 numbers, they are stored on-board as floating point 64 (FP64) numbers (Conversion Code 0x01).

# Additional Features

## CANopen

The CANopen feature on ACR series controllers provides standardized network communication and flexible configuration for motion control.

### Limited Amounts of Nodes and I/O

- 4 external I/O nodes
- 64 bytes (512 bits) of digital inputs total for 4 nodes
- 64 bytes (512 bits) of digital outputs total for 4 nodes
- 32 analog inputs total for 4 nodes
- 32 analog outputs total for 4 nodes

### Alternate Mapping of Digital I/O

The current version of ACR9000 firmware does not allow flags numbered higher than 8191 to be accessed by the PLC programs. The digital I/O mapping option (P32771) allows the first I/O bits of one or more nodes to appear at the flags that had been used for the XIO boards of other ACR products (P4104-P4111).

The value of P32771 is evaluated and implemented each time the network is started (via bit 11265). Values of P32771 less than or equal to zero do not result in any re-mapping, so CANopen digital I/O appears at the original location. Values of 1, 2, or 3 will result in the equal re-mapping of node 0 only, node 0 and 1 only, or all 4 nodes respectively. The meaning of P4104-P4111 is given below for the various values of P32771.

XIO Flags Parameters	P32771 = 1	P32771 = 2	P32771 >=3
4104	Node0 DI 0-31	Node0 DI 0-31	Node0 DI 0-31
4105	Node0 DO 0-31	Node0 DO 0-31	Node0 DO 0-31
4106	Node0 DI 32-63	Node0 DI 32-63	Node1 DI 0-31
4107	Node0 DO 32-63	Node0 DO 32-63	Node1 DO 0-31
4108	Node0 DI 64-95	Node1 DI 0-31	Node2 DI 0-31
4109	Node0 DO 64-95	Node1 DO 0-31	Node2 DO 0-31
4110	Node0 DI 96-127	Node1 DI 32-63	Node3 DI 0-31
4111	Node0 DO 96-127	Node1 DO 32-63	Node3 DO 0-31

Any digital input or output of any node that appears in this table will not appear in the standard mapping of CANopen digital I/O. In

other words, each I/O bit is controlled by only one flag. In addition, this table represents the maximum amounts of I/O that can appear at XIO flag parameters 4104-4111. For example, if P32771= 1 and Node 0 only has 32 physical inputs and outputs, only flag parameters 4104 and 4105 have meaning.

### Semi-Automatic Network Configuration

The network configuration is as automatic as possible, but the user must adjust some settings. The ACR9000 controller automatically sets other configuration parameters required for CANopen, including the global analog data enable (For more information, see the Parker I/O manual). The table below gives the parameters the user must set, along with their default values. The default values apply on power up if user supplied values have not been saved with the **ESAVE** command. Each parameter is described in further detail in subsequent paragraphs.

Parameter	P number	Default value
Master Node Id	P32768	5
Bit Rate (kilobits/second)	P32769	125
Number of slave nodes	P32770	1 (valid range 0-4)
Cyclic Period (milliseconds)	P32772	50
Node 0 ID (required if P32770 > 0)	P33024	1
Node 1 ID (required if P32770 > 1)	P33040	0
Node 2 ID (required if P32770 > 2)	P33056	0
Node 3 ID (required if P32770 = 4)	P33072	0

### Bit Rate and Node Addresses

Every node on a CANopen bus must have a unique ID number, and must use the same bit rate. The slave I/O nodes have DIP switches that allow the user to set bit rate and node ID number. ACR9000 will have a default node ID number of 5, but this may be changed by modifying parameter P32768. The user must set a ACR9000 parameter (P32769) to allow the master to know and set its bit rate to match the nodes on the bus. The bit rate may only be set as high as allowed by the bus length and the existing nodes. This will usually be 1 megabit/second.



For available bit rates and constraints of bus length, see the CiA Draft standard 301, version 4.02, table 2. The default bit rate is 125Kbit/second. Bit rate and master node numbers are saved with the **ESAVE** command.

## Transmission Cycle Period

ACR9000 uses a periodic cyclic transmission protocol between the master and the nodes for digital and analog outputs, and for analog inputs. Digital inputs transmit to the ACR9000 only when their input state has changed. Each cycle, the master sends a synchronization message to all slave nodes. The slave nodes respond by latching and transmitting back their analog inputs, and by asserting the output states commanded by the master before the synchronization message. The cycle period should be calculated to be as fast as possible, and is dependent on the bit rate, the node types, and the number I/O bits on the nodes. Two factors limit the speed of the transmission cycle. One is the total amount data that needs to be transmitted at the selected bit rate. The other is the processing load of the slowest node on the bus.

For the former constraint, the number of bits is divided by the bit rate for the required time. Bits are sent in messages of 125 bits each. Each node has messages for its data, plus one to report health. The ACR9000 also sends a sync message. In the formulas below, digital inputs are ignored, since these will not transmit periodically.

$$\text{Node messages} = (\text{node analog inputs} + 3)/4 + (\text{node digital outputs} + 63)/64 + (\text{node analog outputs} + 3)/4 + 1$$

$$\text{Total messages} = \text{Sum of Node messages} + 1$$

$$\text{Required time (milliseconds)} = (\text{Total messages} * 125) / \text{bit rate in Kilobits/s}$$

This time should be rounded up to the next higher integer number of milliseconds. For example, suppose there are two nodes. One node has 100 digital outputs and 10 each analog inputs and outputs. The second node has 20 digital outputs and 5 each analog inputs and outputs. The first node has nine messages, and the second has six messages. The total is 16 messages. At the 1-megabit rate, 2 milliseconds are required. At the 125K rate, 16 milliseconds are required.

$$(16 * 125)/1000 = 2$$

$$(16 * 125)/125 = 16$$

The second constraint is individual node speed. Parker offers the PIO-337 and PIO-347 fieldbus couplers, and these have been characterized for speed. The time required depends on the coupler and the amount and type of I/O on the coupler. There is a base time required just to respond to the ACR9000's sync signal, plus additional time per point. The sum represents minimum type required by the node. Using the first node of the example above, and the timing in the table below, the time using a PIO-347 would be 31 milliseconds, and using a PIO-337 would be five milliseconds. Using the second

node of the example above, and the timing in the table below, the time using a PIO-347 would be 12 milliseconds, and using a PIO-337 would be two milliseconds.

Node Type	Base time (milliseconds)	time/digital point (microseconds)	time/analog point (microseconds)
PIO-347	5	100	270
PIO-337	1	15	40

## Health Period and Node Health

Node health is a way for the master to periodically (known as the Health Period) ascertain that all nodes are still alive, and to respond appropriately if one goes “off line”. ACR9000 uses the Heart Beating protocol for nodes that support it, and Node Guarding protocol for other nodes. These are standard CANopen features. Compatibility is determined automatically when the network is started. The Health period is set to 10 times the Cycle Period.

## Starting and Configuring the Network

An ACR9000 network master may start and reset the network at any time. When the network is started via bit 11265, the ACR9000 initially places all slave nodes into the “Pre-operational” state. During this state, the ACR9000 interrogates and configures the slaves as required. The slaves are then placed into the “Operational” state, and automatic transfer between the slave’s physical I/O and the ACR9000’s I/O parameters and bits takes place.

Before the network may become in the “Operational” state, the master must know how many slave nodes there are, what the node numbers are, and how many and what type of I/O are on each node.

In some applications, the external nodes may be powered after ACR9000, and hence not available for configuration on ACR9000’s power up. For this reason, the ACR9000 user is required to explicitly request network start via a control flag. The flag (bit 11265) is used for starting the network. The flag is self-clearing (cleared automatically by ACR9000 when the attempt to start the network has completed). There are also status bits and parameters to indicate the results of starting the network. Examples would be error bits, bit rate, cycle period, node status, etc. A typical application scenario would be as follows.

- Perform application initialization, and dwell or otherwise determine that external nodes are powered up.
- Write to any required parameters if the values are not yet correct.
- Assert bit 11265 requesting I/O network start.

- Check for success and any other status of interest. For example, application operation may depend on I/O present, or expected I/O may be verified.
- Proceed with application that depends on external I/O

### *AcroBASIC Language Access to CANopen I/O*

All “objects” (for example steppers, encoders, axes, and masters) in an ACR controller may be accessed via bits and parameters as well as commands. In many cases, (for example, ADC inputs) the values may be accessed only through bits or parameters. An external digital input or output is the same in function and use as an on board digital input or output, and are used in the same way in the language. This is true not just for **SET** and **CLR**, but for **IF**, **WHILE**, **INH**, **LD**, and any other command that has a flag as an argument. This also applies to using parameters with analog I/O. To be consistent with the current language, extend all existing on board I/O functionality to external I/O, and facilitate backward compatibility with existing applications, external I/O are represented with bits and parameters in exactly the same way onboard I/O is.

### Network and Node Information Parameters and Flags

After ACR9000 has started the CANopen network, and discovered and characterized nodes on the network, it fills in an information parameter block for the network and each discovered node. It also updates the Extended I/O Control/Status flags shown below.

Extended I/O Control/Status (P4448)	Flag Number
<b>Control Flags</b>	
Start Network	11265
Reset Network	11266
Reserved	11267
<b>Status Flags</b>	
CANopen controller installed	11268
Network Operational	11269
Network Start Failed	11270
Node Failure	11271
SW Rx Overflow	11272
HW Rx Overflow	11273

Field Description	Read/ Write	Description
Start Network	R/W	When set, this flag will attempt to communicate with the CANopen network. This flag is automatically cleared by the controller when the attempt to start the network has completed. See the section on "Starting and Configuring the Network" for more details.
Reset Network	R/W	When set this flag will reset all of the Extended I/O nodes. This may be needed if there is a baud rate, node ID, wiring change, unrecoverable error or a loss in communications.
CANopen Controller Installed	R	This flag is set if the controller has the CANopen hardware and cleared if it does not.
Network Operational	R	This flag is set when the CANopen network is in the "Operational" state and communicating. It is cleared if there is no communication or some other error. Check the below flags for more information on the error, the CANopen LED or the <b>DIAG</b> command.
Network Start Failed	R	This flag is set when a request to start the network was issued and there was a failure. Check the below flags for more information, the CANopen LED and the <b>DIAG</b> command.
Node Failure	R	This flag is set when one, more nodes are lost, or not responding while the network is operational. Check the below flags for more information, the CANopen LED and the <b>DIAG</b> command.
SW Rx Overflow	R	A flag indicating that the software receive buffer has overflowed.
HW Rx Overflow	R	A flag indicating that the hardware receive buffer has overflowed.

The description and parameter numbers are shown in the following table. The control parameters are those that should be set before attempting to start the network. The status parameters are those that the controller will set because of attempting to start the network.

Extended I/O Control/Status	
<b>Control Parameters</b>	
Master node ID	P32768
Bit Rate (Kb)	P32769
Number of slave nodes	P32770
Alt Digital I/O Mapping	P32771
Cyclic Period (milliseconds)	P32772
<b>Status Parameters</b>	
Health Period (milliseconds)	P32773
Reserved	P32774
Number of digital inputs bytes	P32775
Number of digital outputs bytes	P32776
Number of analog inputs	P32777
Number of analog outputs	P32778
Bus state (see table below)	P32779
Reserved	P32782
Reserved	P32783

Field Description	Read/Write	Description
Master Node ID	R/W	The controller's ID in the CANopen Network
Bit Rate	R/W	The bit rate in Kb for the CANopen Network
Number of Slave Nodes	R/W	The number of slave nodes not including the controller/master.
Alternate Mapping of Digital I/O	R/W	Remap CANopen Digital Inputs and Outputs to lower XIO bits. See Alternate Mapping of Digital I/O section.
Cyclic Period	R/W	The time between updating data on the network.
Health Period	R	The Health period this is always set to 10 times the Cyclic Period. See the "Health Period and Node Health" section for more detail.
Number of Digital Input Bytes	R	The total number of bytes (1 byte = 8 bits) taken for digital inputs on the network.

Field Description	Read/Write	Description
Number of Digital Output Bytes	R	The total number of bytes (1 byte = 8 bits) taken for digital outputs on the network.
Number of Analog inputs	R	The total number of analog inputs on the network.
Number of Analog Outputs	R	The total number of analog outputs on the network.
Bus State	R	Indicates the current bus state. See the next page for more detail on what this value means.

The CANopen STATUS LED table below gives the possible LED indicator states and the corresponding CAN state and controller. The only normal states are "PRE-OPERATIONAL" and "OPERATIONAL". Any red in the CAN LED indicates a problem. All states listed below are consistent with CiA DR-303-3 "Indicator Specification", although not all possible states listed in that document can occur in the ACR9000. In addition, the "off" and "blinking red" indications are unique to the ACR9000, not included and not conflicting with the states listed in CiA DR-303-3 "Indicator Specification".

The CANopen status LED is located just below the CANopen connector on the ACR9000.

CANopen STATUS LED	CiA DR 303-3 CAN state	Description	Possible ACR9000 state(s)
OFF	N/A	No CAN controller detected	0
Blinking Green	Pre-Operational	CANopen is in the pre-operational state.	1,3,4,5
Solid Green	Operational	The network is now exchanging data	2
One Red blink inside blinking Green	Warning limit reached	At least one of the error counters of the CAN controller chip has reached or exceeded the warning level (too many error frames)	6
Two Red blinks inside blinking Green	Error control event (Health event)	A guard event or heartbeat event has occurred.	7
Solid Red	Bus Off	The CAN controller is bus off	10
Blinking Red	N/A	ACR internal error or transmission overrun	8,9

The **Bus State Description** table below gives the possible bus states and the corresponding CAN LED indicator state. The only normal states are “READY TO START” and “NETWORK STARTED”. Any red in the CAN LED indicates a problem.

Bus State Description (parameter P32779)	Bus State	CAN LED State
PRE-INITIALIZED. The network has not been initialized yet. This should only happen during power up or reset. If the CAN LED stays OFF, it indicates that the ACR9000 did not detect its internal CAN controller chip.	0	off
PRE_OPERATIONAL. The user’s node information and bit rate have been verified and the CAN controller is ready to accept the “start network” bit. (11265)	1	Blinking Green
NETWORK STARTED. Successful network start.	2	Solid Green
INVALID MASTER NODE ID. The ACR9000 node ID must be between 1 and 127 inclusive.	3	Solid Red
INVALID MODULE NODE INFORMATION. The module node IDs must be between 1 and 127 inclusive, must be unique, and not the same as the master node ID. A maximum of 4 module nodes is allowed.	4	Solid Red
CHARACTERIZATION ERROR. An expected external node has not responded to interrogation during attempt to start network. Will occur if a stated node ID does not match the actual node ID, or if the node is missing or at the wrong bit rate or not operational. The network is still ready to start once the external node problem is resolved.	5	Blinking Green
EXCESS BUS ERRORS. The controller chip has too many bus errors. One possible reason would be incorrect bit rate on one or more modules.	6	One Red blink inside blinking Green
HEALTH EVENT. A node has stopped sending heartbeat or node guard responses. The errant node will have a node state of 0 (dead). See table below. One possible reason would be node receive overrun caused by a cyclic period that is too fast for the node.	7	Two Red blinks inside blinking Green
INTERNAL ERROR. A firmware or hardware internal error has occurred on power up or after an attempt to start the network. Requires factory consultation	8	Blinking Red
TRANSMISSION OVERFLOW. The amount of data that must be transferred each cyclic update is greater than the bit rate allows. Increase the bit rate or decrease the cyclic rate.	9	Blinking Red
BUS OFF. The CAN controller is bus off, and the network must be re-started.	10	Solid Red

The Node ID must be set by the user to match the node ID settings on the actual nodes. All other node information is filled in by the controller after the network is started. The node information is saved with the **ESAVE** command, and user applications may use it to verify expected network configuration, or make run time application decisions.

This information could serve as a source for a front-end software GUI that displays bus and node status, although no configuration would be possible. Another possibility would be to implement a sort of “Network Configuration Verify” command that would allow the application to easily verify that the configuration is the same every time.

In the table below, nodes are numbered 0-3, like all other ACR objects. This is the node number, from the ACR9000 point of view. The node ID is the setting on that node’s DIP switch, and must be between 1 and 127, but may not conflict with the chosen Master node ID.

Description/Node number	0	1	2	3
Node Id	33024	33040	33056	33072
Number of Digital Inputs (bytes)	33025	33041	33057	33073
Number of Digital Outputs (bytes)	33026	33042	33058	33074
Number of Analog Inputs	33027	33043	33059	33075
Number of Analog Outputs	33028	33044	33060	33076
Health Type (0=not present, 1=heartbeat, 2= lifeguarding)	33029	33045	33061	33077
Node state (0=dead, 1=live)	33030	33046	33062	33078



## Flags for Extended Digital I/O

Each possible node will have two blocks of flag parameters, each 16 parameters in length, to accommodate the possible 512 bits each of extended digital inputs and outputs. Flag parameter numbers are shown the table below.

32 bit block type	Starting parameter	Ending parameter
Node 0 digital inputs	4456	4471
Node 0 digital outputs	4472	4487
Node 1 digital inputs	4488	4503
Node 1 digital outputs	4504	4519
Node 2 digital inputs	4520	4535
Node 2 digital outputs	4536	4551
Node 3 digital inputs	4552	4567
Node 3 digital outputs	4568	4583

For each node, the lowest bit number for extended digital inputs block of that node will correspond the lowest numbered digital input on that node on the network. Numbering will proceed upward for all the digital inputs on that numbered node. The same process occurs for the Digital Outputs. This continues until the actual number of digital inputs and outputs on the network or maximum number (512) of digital I/O is reached. For example, the first digital input on node 0 is bit 11520, and the first digital input on node 2 is bit 13568.

Each node will have an information parameter block, described later in this text. This block will contain, among other things, the number of bytes of digital inputs and outputs. Digital I/O are assigned in blocks of eight, so the number of bits assigned to each node is a multiple of eight. For example, suppose node 2 has 12 digital inputs. Node 2's inputs would be bits 13568-13579, even though the node status parameter indicates that it has two bytes of inputs. The same numbering rules apply to digital outputs.

## Analog Inputs and Outputs

Analog inputs and outputs are implemented by ADCs and DACs respectively, and unlike digital I/O, the analog values represent something with units and a range. For example, a DAC might assert -5V to 5V, or 0-20 mA, or some range of pressure, force, or speed. The ADCs and DACs also have variable binary resolution (10, 12, 14 or 16 bits). All CANopen values are left shifted to occupy the entire 16 bits as a two's complement signed number, even if the actual ADC or DAC is less than 16 bits. This does not increase the analog resolution. In addition, the sign of the resulting 16-bit number is the same as the sign of the physical quantity it represents instead of being offset. A value of 32767 represents full scale positive for the device, and -32768 represents full scale negative for the device.

For example a 0-10V DAC would take values of 0-32767, and a  $\pm 10V$  device would take values of  $-32768$  to  $32767$ . However, a  $\pm 5V$  device would also take values of  $-32768$  to  $32767$ . To translate from this raw binary number to the range and units being controlled or measured, ACR9000 employs entered offsets and gains.

An offset has the same units as the user units of the analog value, for example volts or milliamps, and translates the center of the analog range to a value that allows a gain to be applied. A DAC gain has the units of full-scale binary resolution per user unit. The DAC range is 16-bit or 65536 DAC counts, regardless of the actual DAC resolution.

For example, suppose a 12-bit DAC asserts  $-10V$  to  $+10V$ , where a value of  $32768$  will assert  $-10V$  and  $32767$  will assert  $+10V$ . In this case, the offset is  $0V$ , and the gain is  $(65536/20 = 3276.8)$ . If the user wants to assert  $7.5V$ , a value of  $7.5 * 3276.8 = 24576$  must be written to the DAC.

The process is different for an ADC. An ADC gain has the units of full-scale user units. For example, if the input of the analog device were a maximum of  $\pm 10V$ , then the gain would be  $10$ . Alternatively, if the input of the analog device were a maximum of  $\pm 20ma$ , then the gain would be  $20$ . Internally the raw analog count value is normalized such that  $\pm 1.0$  represents full scale positive and negative before the user gain is applied, and user offset added.

The ACR9000 automatically performs this arithmetic so that the analog values appear to the user as user units, not raw DAC or ADC counts. The user must know the analog range of the DAC or ADC in order to calculate the appropriate gain for entry into the ACR9000 parameter structure. Offset values will usually be zero unless an actual physical offset is required. ACR9000 uses default values for gains and offsets if the user does not overwrite the defaults. All default-offset values are zero. All default ADC gains are ten ( $10.0$ ), and all default DAC gains are  $3276.8$ .

The DAC and ADC values, gains, and offsets are accessed in blocks of eight parameters each, as shown in the table below. Since each node may accommodate all 32 analog inputs and outputs, a range of 512 bits is reserved for each node. The parameter numbers correspond to a range of 33280-33791 for the lowest numbered node, 33792-34303 for the next node, etc. The table below shows the parameter mapping for the lowest number node. For each higher number node, add 512.

DAC Parameter/DAC number	0	1	...	31
DAC Output Value	P33280	P33296	...	P33776
Reserved	P33281	P33297	...	P33777
DAC Gain	P33282	P33298	...	P33778
DAC Offset	P33283	P33299	...	P33779
Reserved	P33284	P33300	...	P33780
Reserved	P33285	P33301	...	P33781
Reserved	P33286	P33302	...	P33782
Reserved	P33287	P33303	...	P33783

ADC Parameter/ADC number	0	1	...	31
ADC Input Value	P33288	P33304	...	P33784
Reserved	P33289	P33305	...	P33785
ADC Gain	P33290	P33306	...	P33786
ADC Offset	P33291	P33307	...	P33787
Reserved	P33292	P33308	...	P33788
Reserved	P33293	P33309	...	P33789
Reserved	P33294	P33310	...	P33790
Reserved	P33295	P33311	...	P33791

These tables appear similar to the other parameter tables for ACR DACs and ADC's, but there is no relationship in function. Nor do the other DAC and ADC commands have any function for ACR9000 extended analog I/O. The DAC commands assume their use as command outputs for drives, and ACR9000 does not have the type of ADCs that are assumed by other ADC commands.

## Saved Parameters

All the parameters required to set up the extended I/O network are saved with the **ESAVE** command, and automatically recalled on power up. In addition, some of the parameters determined by the controller, such as the total number of analog and digital I/O, are also saved with the **ESAVE** command. This allows an application to compare the total I/O expected before the network is started with the actual amount found when the network is started. The exact parameters saved and recalled are P32768 through P32778, the node IDs for each node, and the gains and offsets for all DAC and ADC parameter blocks of each node.

### Example 1

The following example uses two Parker I/O nodes. The first, configured as node 3, has a PIO-337, four digital inputs, four digital outputs, four analog inputs (0 to 10 VDC) and two analog outputs (0 to 10 VDC). The second, configured as node 4, has a PIO-347, four digital inputs, four digital outputs, four analog inputs (0 to 10 VDC)

and two analog outputs (0 to 10 VDC). They are both configured at a bit rate of 1 Mb. The example shows the required setup, and how to use the data in a very basic program.

```

P32768 = 5 : REM SET THE CONTROLLER ID TO 5
P32769 = 1000 : REM SET THE BIT RATE TO 1 Mb
P32770 = 2 : REM TELL THE CONTROLLER THERE
:REM ARE 2 SLAVES ON THE NETWORK
P33024 = 3 : REM SET NODE 0 TO PHYSICAL NODE 3
P33040 = 4 : REM SET NODE 1 TO PHYSICAL NODE 4
P33056 = 0 : REM SET NODE 2 TO NOTHING
P33072 = 0 : REM SET NODE 2 TO NOTHING
P32772 = 50 : REM SET THE CYCLIC PERIOD TO 50 ms
SET11265 : REM START THE NETWORK
DWL1 : REM DWELL FOR A SECOND TO ALLOW THE
REM NETWORK TO BECOME OPERATIONAL

IF (NOT BIT 11269) THEN SET 11266
REM IF THE NETWORK IS NOT OPERATIONAL AT
REM THIS POINT THEN TRY TO RESET IT

REM MORE CODE MAY BE NEEDED HERE TO ENSURE THE NETWORK IS OPERATIONAL

INH 11520 : REM WAIT UNTIL THE FIRST DIGITAL INPUT ON
REM NODE 0 IS ON

SET 12033 : REM TURN ON DIGITAL OUTPUT 2 ON NODE 0
SET 13057 : REM TURN ON DIGITAL OUTPUT 2 ON NODE 1
IF (P33288 > 5.0) THEN P33792 = 2.5
REM IF ANALOG INPUT 1 FROM NODE 0 IS
REM GREATER THAN 5 VDC THEN SET ANALOG
REM OUTPUT 1 ON NODE 1 TO 2.5 VDC
INH -11520 : REM WAIT UNTIL THE FIRST DIGITAL INPUT ON
REM NODE 0 IS OFF
CLR 12033 : REM TURN OFF DIGITAL OUTPUT 2 ON NODE 0
CLR 13057 : REM TURN OFF DIGITAL OUTPUT 2 ON NODE 1
P33792 = 0 : REM RESET ANALOG OUTPUT 1 ON NODE 1 TO 0

```

## Example 2

```

#DEFINE ResetCANNetwork BIT151

PROGRAM

GOSUB EnableCANopen

END

_EnableCANopen

P32768 = 5 : REM SET THE CONTROLLER ID TO 5
P32769 = 125 : REM SET THE BIT RATE TO 125 kbps
P32770 = 1 : REM TELL THE CONTROLLER THERE IS 1 SLAVE ON THE NETWORK
P33024 = 1 : REM SET NODE 0 TO PHYSICAL NODE 1

P32772 = 50 : REM SET THE CYCLIC PERIOD TO 50 ms
SET 11265 : REM START THE NETWORK
INH -11265 : REM INHIBIT PROGRAM UNTIL START NETWORK HAS FINISHED

'IF THE NETWORK IS NOT OPERATIONAL AT
'THIS POINT THEN TRY TO RESET IT

IF (NOT BIT 11269)
    SET 11266 : REM RESET NETWORK
    SET ResetCANNetwork : REM SET RESET NETWORK LATCHED BIT
    INH -11266 : REM INHIBIT PROGRAM UNTIL NETWORK RESETS
    SET 11265 : REM START NETWORK AGAIN

```

```
INH -11265 : REM INHIBIT PROGRAM UNTIL START NETWORK HAS FINISHED
ENDIF

'CHECK IF NETWORK IS STILL NOT OPERATIONAL
'AND ALREADY RESET NETWORK

IF ((NOT BIT 11269) AND (ResetCANNetwork))
  PRINT "CANopen network problem occurred."
ENDIF

RETURN

ENDP
```

## Drive Talk

The Drive Talk feature on ACR series controllers provides communication with Aries drives through the Axis connectors. You can include Drive Talk in programs and PLC programs. Machine builders, for example, could configure and monitor drive data—such as motor and drive temperatures, drive under or over voltages, and excessive torque—through a custom HMI status panel.

Drive Talk lets you:

- Set the controller to automatically assign addresses to Aries drives. Subsequently, programs can use axis aliases and the controller manages the drive address-prefixing.
- Get existing drive configuration data, and send new configuration data.
- Get drive status data.
- Set which error data the Aries drive logs.

### *Communication*

The Axis connectors provide an RS-485 communication interface to the drive through the COM2 port. Parker drives supporting Drive Talk automatically detect RS-232/485 on power up; therefore, the drives must be connected to ACR series controller before being powered up. Otherwise, the drives set the communication interface as RS-232.

### *Parameters and Bits*

Drive Talk uses the following parameters and bits:

- P28672–P28672 Drive Talk Parameters
- Bit8960–Bit9455 Drive Talk Error-Log Flags
- Bit9472–Bit9983 Drive Talk Drive-Status 1 Flags
- Bit9984–10495 Drive Talk Drive-Status 2 Flags
- Bit10496–Bit11007 Drive Talk Drive-Control Flags
- Bit 11040–Bit11071 Stream Flags for Drive Talk—LPT1

- Bit11072–Bit11103 Stream Flags for Drive Talk—COM1
- Bit11104–Bit11135 Stream Flags for Drive Talk—COM2
- Bit11168–Bit11199 DPCB/Stream 3 Flags for Drive Talk
- Bit11200–Bit11231 Stream 4 Flags for Drive Talk
- Bit11232–Bit11263 Stream 5 Flags for Drive Talk

## *Auto-Addressing*

You can have the controller automatically assign address numbers to drives that are connected and use the Drive Talk feature.

By default, auto-addressing is disabled. When enabled, an ACR controller assigns addresses only to the Aries drives connected and powered up.

For all Aries drives, the default address is zero—zero represents a non-address to the drive. Therefore, the first acceptable address is one.

The ACR controllers assigns each drive an address relative to the axis to which the drive is connected. As the numbering for controller axes begins with zero and the drives cannot accept an address of zero, the addressing scheme is “off” by one. This is best illustrated through an example.

For example, you have a eight axis ACR controller, and axes 0, 1, 4, and 7 are connected to drives with the Drive Talk feature. The auto-address sequence is as follows: the drive connected to axis 0 is assigned address “1”; the drive connected to axis 1 is assigned address “2”; the drive connected to axis 4 is assigned address “5”; and the drive connected to axis 7 is assigned address “8”.

## **Enabling Auto-Addressing**

- ▶ To enable auto-addressing, set the “Auto Address Request” bit (bit index 0, Drive Talk Drive-Control Flags).

## *Drive Control Flags*

The “Drive Talk Drive Control Flags” let you get and send configuration data, set up the Aries error log, and retrieve status data.

**NOTE:** All Drive Talk control bits are self-clearing. To perform an action one time, set the control bit. When the bit is cleared, the action is complete or the action has timed out.

## **Configuration**

You can get and send the configuration data of an Aries drive. On power up the controller does not contain any drive configuration data. When you get drive configuration data, the controller stores it in the “Drive Talk Parameters”.

## Upload

- ▶ To upload configuration data, set the "Get Configuration Request" bit (bit index 1, "Drive Talk Drive-Control Flags").

## Download

- ▶ To download configuration data, set the "Send Configuration Request" bit (bit index 2, "Drive Talk Drive-Control Flags").

## Error Log Flags

You can set the Aries drive to log errors you are concerned with. Using the "Drive Talk Error-Log Flags", set the bits for those errors you want to monitor. Then use the "Send ERRORL Request" bit to send the request to the Aries drive. The Aries drive logs the error data as text.

Because the Aries error log is maintained as a text file, there is no parameter or bit data the ACR controller can get. You can read the error log by directly accessing the Aries drive. For more information, see the section titled *Using the "DTALK" Mode* (below), and the *Aries User Guide*, p/n 88-021610-01.

- ▶ To indicate what errors a drive is to log, set the bits in "Drive Talk Error-Log Flags."
- ▶ To send the error data request, set the "Send ERRORL Request" bit (bit index 3, "Drive Talk Drive-Control Flags").

## Drive Status Flags

You can get status data of an Aries drive. On power up the controller does not contain drive status data. In the "Drive Talk Drive-Control Flags" (bit index 8-25) you can select what status data the controller gets. Then set the "Get Drive Data Request" bit (bit index 4) to retrieve the status data. The controller stores the drive status data in the "Drive Talk Parameters".

The "Drive Talk Drive-Control Flags" also contain "Drive Talk Drive Status 1" and "Drive Talk Drive Status 2" bits (bit indexes 28 and 29). Unlike bit indexes 8-25, the data retrieved for bit indexes 28 and 29 are stored in the "Drive Talk Drive Status 1 Flag" and "Drive Talk Drive Status 2 Flag" bits.

- ▶ To indicate what status data you want, set the "Drive Talk Drive-Control Flags" (bit index 8-29).
- ▶ To get drive status data, set the "Get Drive Data Request" bit (bit index 4, "Drive Talk Drive-Control Flags").

**NOTE:** The rate at which the controller updates data is governed by the number of participating axes and the baud at which Drive Talk communication is set.

## Using Drive Talk

The most sensible way to enable Drive Talk is through a program. If you have a startup program (see the **PBOOT** command) for your ACR controller, consider including the Drive Talk code in it.

**NOTE:** Be sure all Aries drives are connected to the ACR controller before power up (due to the Aries communication auto-detect—see the section titled *Communication*, above).

To enable Drive Talk, do the following:

1. Send the **OPEN DTALK** command as follows:  
`OPEN DTALK "COM2:9600,N,8,1" AS #1`
2. Set the "Communication Device" parameter (in "Drive Talk Parameters") for each axis to which an Aries drive is connected.
3. Set the "Drive Type" parameter (in "Drive Talk Parameters") to zero (Aries) for each axis to which an Aries drive is connected.
4. Clear the "Stream Drive Lost", "Stream Drive Timeout", and "Stream Address Error" bits for COM2 (bits 1112, 11123, and 11124 in "Stream Flags for Drive Talk COM2").
5. Set the "Auto Address Request" bit (in "Drive Talk Drive-Control Flags") for each axis to which an Aries drive is connected.

Once set up, you can do the following You can then get and send configuration data, set the error log for the drive, and get drive status data.

### Example

The following example demonstrates the set up for two axes with Aries drives:

```
OPEN DTALK "COM2:9600,N,8,1" AS #1 REM OPEN PORT
P28672=1 : REM SET DEVICE NUMBER FOR DRIVE 1
P28928=1 : REM SET DEVICE NUMBER FOR DRIVE 2
P28673=0 : REM SET DRIVE TALK AXIS1 TO ARIES DRIVES
P28929=0 : REM SET DRIVE TALK AXIS2 TO ARIES DRIVES
CLR 11122 : REM RESET TIMEOUT
CLR 11123 : REM RESET TIMEOUT
CLR 11124 : REM RESET TIMEOUT
SET 10505 : REM GET TPE AXIS0 USING GET DRIVE DATA
SET 10500 : REM UPDATE DATA AXIS0 USING
REM GET_DRIVE_DATA_REQUEST
SET 10537 : REM GET TPE AXIS1 USING GET DRIVE DATA
SET 10532 : REM UPDATE DATA AXIS1 USING
REM GET_DRIVE_DATA_REQUEST
?P28693 : REM SHOW TPE AXIS0 ON TERMINAL
?P28949 : REM SHOW TPE AXIS1 ON TERMINAL

SET 10500 : REM GET TPE AXIS1 USING GET DRIVE DATA
SET 10532 : REM UPDATE DATA AXIS1 USING
REM GET_DRIVE_DATA_REQUEST
?P28693 : REM SHOW TPE AXIS0 ON TERMINAL
?P28949 : REM SHOW TPE AXIS1 ON TERMINAL
```

## Closing Drive Talk

- ▶ To close a Drive Talk session, use the **CLOSE** command.



## Using the “Pass Through” Mode

To communicate directly to the Aries drive, you can set the ACR controller into a “pass through” mode—where the controller acts as a communication conduit to another device. Use the “pass-through” mode to trouble shoot the Aries drive, or run a program and monitor its progress and output (see **LRUN** command).

**NOTE:** When set in the “pass through” mode, the ACR controller no longer accepts AcroBASIC commands.

Think of the commands functioning like a switch. The ACR controller accepts AcroBASIC commands until it enters Drive Talk. Once in Drive Talk, the controller communicates with the Aries drive—programs and PLCs can get and send configuration data, and get drive status data. In “pass through” mode, the controller acts as a communication conduit to the drive.

The following diagram helps illustrate the switch concept:

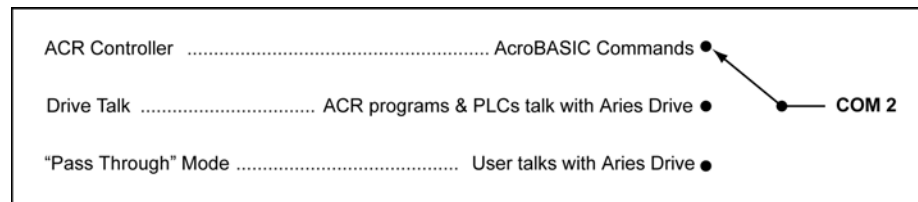

Because the “pass through” mode is an extension of Drive Talk, you first have to enable Drive Talk on the ACR controller. Once enabled, you can then enter the “pass through” mode. To do this, send the **DTALK** command from a terminal. For more information, see **DTALK** in the *ACR Command Language Reference*.

Once in “pass through” mode, you can communicate with an Aries drive using its native command language.

**NOTE:** You can only use the **DTALK** command to set the controller into the “pass through” mode. Subsequent communication with the Aries drive is performed through a terminal, using the Aries command language. Do not use the **DTALK** command in a ACR controller program or PLC.

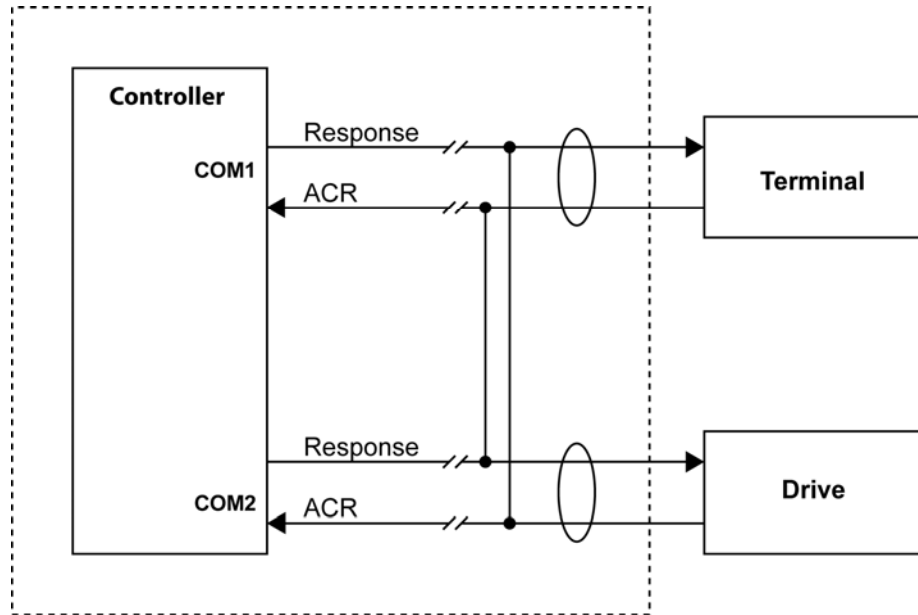

### Example

The following example opens a Drive Talk session, then enters the "pass through" mode.

```
P00>OPEN DTALK "COM2:9600,N,8,1" AS #1 : REM OPEN DRIVE TALK PORT FOR REM
DEVICE NUMBER 1
P00>P28672=1 : REM SET AXIS0'S DEVICE NUMBER FOR DTALK
REM TO 1, MUST MATCH THE OPEN COMMAND ABOVE
P00>P28673=0 : REM SET AXIS0 TO AN ARIES DRIVE
P00>CLR11122 CLR11123 CLR11124 : REM CLEAR ALL TIMEOUT BITS
P00>SET11104 : REM START AUTO ADDRESS
P00>DTALK X : REM START TALKING DIRECTLY TO THE DRIVE

REM PRESS ESCAPE TO EXIT
TPE
*0
TPE
*2576
TREV

*Aries OS Revision 2.00
DMODE
*2

P00>
```

### Exiting "Pass Through" Mode

Exiting the "pass through" mode and closing the Drive Talk session are two distinct acts. Though you exit the "pass through" mode, the Drive Talk session remains open. See the section titled *Closing Drive Talk* (above).

- ▶ To exit the "pass through" mode from the terminal, send the escape character (ASCII 27).

## Inverse Kinematics

Kinematics is a branch of mechanics that provides a mathematical means of describing motion. Inverse kinematics looks at a position and works backwards to determine the motions necessary to obtain that position.

Robotic applications frequently use inverse kinematics. Algorithms describe the mechanical system, and translate the rotational motion of robotics into Cartesian coordinates. Consequently, an end user provides simple Cartesian coordinates for an application, and the inverse kinematics calculates necessary movements to reach that position.

Suppose an application has a cutting tool at the end of a 4-axis robotic arm, and an HMI. The controller, using algorithms developed by the application builder, transforms the motion target-points from Cartesian coordinates to rotational coordinates to position the arm joints and cutting tool. Once transformed, the controller interpolates the target points to generate a motion path. See the illustration below:

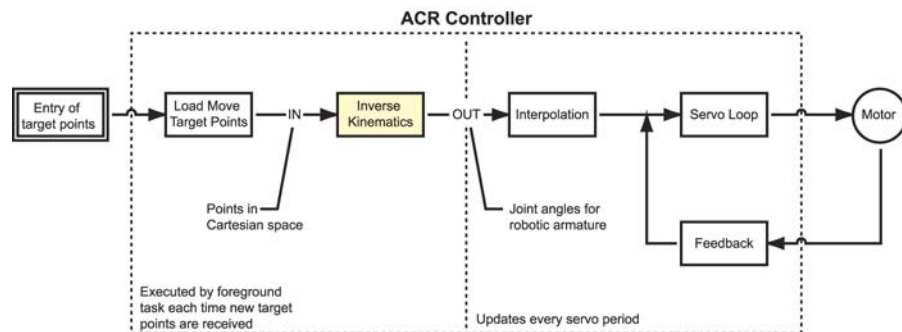

### Programming the Inverse Kinematics

Each application is different. The algorithm for your application can consist of equations, logical expressions, and commands in the AcroBASIC language. You can do the following:

- Store algorithms in any of the programs 0 through 15 (be sure to dimension memory for the program).
- Save the program to Flash memory.
- Use the **PASSWORD** command to protect the program from uploading or listing.
- Include the **INVK** commands in a program, or in the setup before a program.

## Example

The following program results in a circle instead of a straight line because of the transformation described in program 7 (PROG7).

```
PROG7
PROGRAM
P12361= sin( P12360)   : REM Describe transformation in PROG7
P12617= cos(P12360)   : REM Describe transformation in PROG7
ENDP
PROG0
ATTACH MASTER0
ATTACH SLAVE0 AXIS0 "X"
ATTACH SLAVE1 AXIS1 "Y"
PPU X 2000 Y 2000      : REM Scale commands to engineering units
ACC 100 DEC 100 STP 0 VEL 0
INVK PROG7            : REM Tell MASTER0 where the transformation are
INVK ON               : REM Turn on the Kinematics
PROGRAM0_start
X / 0.2               : REM Incremental move in Cartesian space
GOTO start
```

# Troubleshooting

---

When a system does not function as expected, the first thing to do is identify and isolate the problem. When this is accomplished, steps may be taken toward resolution.

## Problem Isolation

The first step is to isolate each system component and ensure that each component functions properly when it is run independently. This may require dismantling the system and putting it back together piece by piece to detect the problem. If additional units are available, it may be helpful to exchange them with the system's existing components to help identify the source of the problem.

Determine if the problem is mechanical, electrical, or software related, and note whether it can be recreated or is repeatable.

Random events may appear to be related, but they are not necessarily contributing factors to the problem.

There may be more than one problem. Isolate and solve one problem at a time.

## Information Collection

Document all testing and problem isolation procedures. If the problem is particularly difficult to isolate, be sure to note all occurrences of the problem along with as much specific information as possible. These notes may come in handy later, and will also help prevent duplication of testing efforts.

Once the problem is isolated, refer to Table 1, [Common Problems and Their Solutions](#). If instructed to contact Parker Technical Assistance, please refer to [Technical Assistance](#) for contact information.

## Troubleshooting Table

This section includes a table of common problems and their solutions.

For locations of the ACR90x0 controllers' status LEDs, and for non-problem indications, see Chapter 2, Specifications, in the *ACR9000 Hardware Installation Guide*. Table 1 in this chapter only lists problem LED indications.

PROBLEM	CAUSE / VERIFICATION	SOLUTION
<b>Power Status LED</b>		
Power status LED is not on	There is no power to the controller.	<p>Check for disconnected power cable.</p> <p>Check for blown fuse.</p> <p>Verify the power source meets requirements outlined in Chapter 2, Specifications, of the <i>ACR9000 Hardware Installation Guide</i>.</p>
Power status LED is steady red	There is inadequate power to the controller.	<ol style="list-style-type: none"> <li>1. Verify the power source meets requirements outlined in Chapter 2, Specifications, of the <i>ACR9000 Hardware Installation Guide</i>.</li> <li>2. Remove all cables except power. <ul style="list-style-type: none"> <li>▶ If the LED turns green after removing the cables, re-attach the cables one at a time to determine which cable or device is causing the problem.</li> <li>▶ If the LED does not turn green, contact Parker Technical Assistance.</li> </ul> </li> </ol>
Power status LED is alternating red/green	Controller encountered error during boot process.	Contact Parker Technical Assistance.

PROBLEM	CAUSE / VERIFICATION	SOLUTION
<b>Axis Status LED</b>		
Axis status LED is not on	Axis is disabled with no fault (normal state for steppers or servo motors).	Enable drive.
Axis status LED is red	Axis fault. Motion on this axis is disabled during a fault state. <b>NOTE:</b> The LED illuminates red whenever the drive fault input is activated (drive faulted, no axis cable connected, etc.)	Check for faulted drive. Enable drive. (Refer to <a href="#">Operation</a> section of this table.) Check for axis cable disconnected.
<b>CANopen LED</b>		
CANopen LED is red, single flash	Excess bus errors: At least one CAN controller error counter has reached or exceeded the warning level (too many error frames).	The controller chip has too many bus errors. One possible reason would be incorrect bit rate on one or more modules.
CANopen LED is red, double flash	Error control event: guard event (NMT-slave or NMT-master) has occurred. Error control event: heartbeat event (heartbeat consumer) has occurred.	Health Event: A node has stopped sending heartbeat or node guard responses. The errant node will have a node state of 0 (dead). One possible reason would be node received overrun caused by a cyclic period that is too fast for the node. Another possible reason is the connection between the master and slave has been severed.
CANopen LED is red, triple flash	Sync error: SYNC message has not been received within the configured communication cycle period timeout.	Object 0x1006 contains the sync cycle period in ms. The sync cycle period time out should be the configured sync cycle period multiplied by 1.5.
CANopen LED is off	Controller is executing a reset.	This is not a problem unless the controller is finished executing a reset. If the LED does not turn on after a reset, check the connection to the controller.
<b>Ethernet Status LED</b>		
Ethernet link/activity: yellow LED is off	No Ethernet link is detected.	Check for the correct type of cable. Verify the cable pinout matches the ACR90x0. (See the section "Ethernet and ETHERNET Powerlink Connectors" in Chapter 2, Specifications, of the <i>ACR9000 Hardware Installation Guide</i> .)
Ethernet speed: green LED is flashing	Ethernet port is getting intermittent 10Mbps and 100Mbps connection.	Verify the Ethernet card in the PC is functioning correctly. Verify the ACR controller Ethernet port is functioning correctly.

PROBLEM	CAUSE / VERIFICATION	SOLUTION
<b>EPL Status LED</b>		
EPL link/activity: yellow LED is off	No Ethernet link is detected.	Check for the correct type of cable. Verify the cable pinout matches the ACR90x0. (See the section "Ethernet and ETHERNET Powerlink Connectors" in Chapter 2, Specifications, of the <i>ACR9000 Hardware Installation Guide</i> .)
Ethernet speed: green LED is flashing	Ethernet port is getting intermittent 10Mbps and 100Mbps connection.	Verify the Ethernet card in the PC is functioning correctly. Verify the ACR controller Ethernet port is functioning correctly.
<b>Serial Communication</b>		
Problem communicating with controller	Incorrect cable.	Check that the serial cable is a null modem serial communication cable.
	Incorrect COM port settings.	Check COM port settings. Bits per second: 38400 Data bits: 8 Parity: None Stop bits: 1 Flow control: XON/XOFF
	Incorrect USB-serial adapter.	Check for an incompatible USB to serial adapter. Recommended: BAFO BF-810
<b>USB Communication</b>		
Communication Error: 17054	USB driver not installed.	Reconnect ACR90x0 controller. Windows will detect new hardware. Install the driver from <a href="#">Parker technical support</a> or CD.



PROBLEM	CAUSE / VERIFICATION	SOLUTION
<b>Ethernet Communication</b>		
Communication Error: 11003	Using straight through (patch) Ethernet cable.	Change to a crossover Ethernet cable.
Communication Error: 11010	Using crossover Ethernet cable through router/hub.	Change to a straight through Ethernet cable.
Communication Error: 11003	Wrong computer IP address and/or subnet mask.	Change IP address of computer in Ethernet card settings.
Communication Error: 10061	Same IP address as ACR9000.	Change IP address of computer in Ethernet card settings.
Communication Error: 11010	Wrong IP address configured in ACR-View communication window.	Enter in correct ACR9000 IP address.
<b>PCI Card Communication</b>		
Controller is not present in Windows Device Manager	AMCSPCI driver card not installed correctly.	Reinsert the ACR1505 or ACR8020. Check for compatible operating systems.
Communication Error: 17080	ACR-View cannot establish communication.	Check PCI communications. Shut down computer and restart.
<b>Operation</b>		
Drive will not enable	Motion enable input is open. Verify by checking Status Panels → Bit Status → Miscellaneous Control Flags.	Check if 24 VDC is applied to the Motion Enable Input. Bit 5646 indicates status of 24VDC Motion Enable Input. Bit 5645 indicates if Motion Enable Input has been latched. If both 5645 and 5646 are set, reapply 24V to Motion Enable Input. If only 5645, then SET 5647 to clear 5645 latch.
	Encoder signal fault and/or encoder signal is lost. Verify by checking Status Panels → Bit Status → Encoder Flags. <b>NOTE:</b> Each encoder input has specific flag sets.	For Encoder Signal Fault: Check for incorrect termination. Noise in the system can cause missed and/or false encoder feedback values. For Encoder Signal Lost: Check feedback cables.
	Amplifier/drive is not powered on.	Check if power is applied to the amplifier/drive.

PROBLEM	CAUSE / VERIFICATION	SOLUTION
	<p>Excess position error (EXC). (Motor has exceeded maximum position error.)</p> <p>Verify by checking Status Panels → Bit Status → Axis Flags → Primary Axis Flags.</p> <p>(Each axis is indicated by Bit “Not Excess Error.”)</p>	<p>Increase the <b>EXC</b> setting.</p>
<p>Drive will enable, but will not hold torque</p>	<p>Incorrect configuration for motor attached.</p> <hr/> <p>Servo motor running open loop.</p> <p>Verify that the drives are running open loop: Status Panels → Bit Status → Axis Flags → Primary Axis Flags.</p> <p>(Each axis is indicated by Bit “Open Servo Loop.”)</p>	<p>Correct the configuration for servo or stepper through the Configuration Wizard.</p>
		<p>Disable drive and clear the appropriate Bit.</p>
	<p>Tuning gains are not set correctly.</p> <p>Check if the tuning gains are set too low: Status Panels → Numeric Status → Axis Parameters → Servo Parameters.</p>	<p>Refer to <a href="#">Servo Tuning Tutorial</a>.</p>
	<p>Torque limit is not set correctly.</p> <p>Verify torque limit setting: Status Panels → Numeric Status → Axis Parameters → Limit Parameters → Plus/Minus Torque Limit.</p>	<p>Example: TLM X1 indicates torque is limited to 10% of drive motor capacity for axis X.</p>

PROBLEM	CAUSE / VERIFICATION	SOLUTION
Drive will enable, but motor will not move	Stepper output motion does not occur. ACR controller not configured for stepper output in Configuration Wizard.	Correct configuration for stepper through Configuration Wizard. Tuning gains must remain at default values: <b>PGAIN</b> 0.002441406; <b>IGAIN</b> , <b>ILIMIT</b> , <b>IDELAY</b> , <b>DGAIN</b> , <b>DWIDTH</b> , <b>FFVEL</b> , <b>FFACC</b> , and <b>TLM=0</b> .
	Axis encountered limits. Verify: Status Panels → Bit Status → Axis Flags → Quinary Axis Flags. (Each axis is indicated by Bit "Positive/Negative End-of-Travel Limit Encountered.")	Clear the appropriate Positive/Negative End-of-Travel Limit Encountered Bit. Clear any Master Kill All Motion Request Bits and Axis Kill All Motion Request Bits.
	Master Kill All Moves request is active. Verify: Status Panels → Bit Status → Master Flags. (Each master is indicated by Bit "Kill All Moves Request.")	Clear the appropriate Master Kill All Moves Request Bit. Also clear all associated Slave Kill All Motion Request Bits.
	Axis Kill All Motion Request is active. Verify: Status Panels → Bit Status → Axis Flags → Quaternary Axis Flags. (Each axis is indicated by Bit "ACR9000 Kill All Motion Request.")	Clear the appropriate Axis ACR9000 Kill All Motion Request Bit.
	Master in feedhold or feedholding state. Verify: Status Panels → Bit Status → Master Flags. (Each master is indicated by Bit "In Feedhold or Feedholding.")	Set the appropriate Cycle Start Request Bit.
	Slave axis not attached to master. Check the configuration by going into the correct PROG level. Type <b>ATTACH</b> .	Correct the configuration through the Configuration Wizard and download the setup code.
	Jog or Master Velocity set to zero (no Master Profile). Check these parameters by going into the correct PROG level. Type <b>VEL</b> or <b>JOG VEL</b> .	Assign Velocity or Jog Velocity values. Example: <b>VEL 1</b> or <b>JOG VEL X 1</b> .
	Commanded feedrate override set to zero. Check the feedrate override by going into the correct PROG level. Type <b>FOV</b> .	Assign the appropriate feedrate override value. Example: <b>FOV 1</b> indicates a master feedrate of 1.

PROBLEM	CAUSE / VERIFICATION	SOLUTION
	Torque Limit is set to zero. Verify Torque Limit setting by Status Panels → Numeric Status → Axis Parameters → Limit Parameters → Plus/Minus Torque Limit	Assign the appropriate Torque Limit value. Example: TLM X1 indicates torque is limited to 10% of drive motor capacity for axis X.
Improper operation	Feedback device counts are missing	Check the feedback cable and connections. Check the amplifier to send back correct signals.
	(for PCI controller cards) Incorrect termination / pull-up resistor.	Check that the correct type of resistor (termination or pull-up) is installed for the type of encoder being used.
Servo motors make audible noise	Incorrect tuning gain settings.	Check tuning gain settings.
	Incorrect motor commutation.	Verify drive settings, motor connections.
Incorrect commanded distance or position	Incorrect move mode, absolute vs. incremental	Make sure the move mode is correct ABS vs. INC.
	Incorrect <b>PPU</b> setting.	Correct <b>PPU</b> setting for position or distance.
Incorrect commanded velocity	Check the commanded velocity by going into the correct PROG level. Type (for example) VEL or JOG VEL X.	Assign the appropriate velocity value. Example: VEL 10 or JOG VEL X 10.
	Check the feedrate override by going into the correct PROG level. Type FOV.	Assign the appropriate feedrate override value. Example: FOV 1 indicates a master feedrate of 1.
Incorrect torque limit	Verify Torque Limit setting by Status Panels → Numeric Status → Axis Parameters → Limit Parameters → Plus/Minus Torque Limit.	Assign the appropriate Torque Limit value. Example: TLM X1 indicates torque is limited to 10% of drive motor capacity.
"Not valid while in motion" message received	Tried to enable/disable axis while motion is commanded.	Check if axis is making coordinated motion: Status Panels → Bit Status → Master Flags. (Each master is indicated by Bit "In Motion.")  Check if the axis is making jog motion: Status Panels → Bit Status → Axis Flags → Primary Axis Flags. (Each axis is indicated by Bit "Jog Active.")

PROBLEM	CAUSE / VERIFICATION	SOLUTION
Motion stops unexpectedly	Axis has encountered soft limits. Verify: Status Panels → Bit Status → Axis Flags → Quinary Axis Flags. (Each axis is indicated by Bit "Positive/Negative Soft Limit Encountered.")	Jog off the limit. Clear the appropriate Positive/Negative Soft Limit Encountered Bit. Clear the associated Master Kill All Moves Request Bits.
	Axis has encountered Positive/Negative End-of-Travel (EOT) Limits. Check if EOT limits have been encountered: Status Panels → Bit Status → Axis Flags → Quinary Axis Flags. (Each axis is indicated by Bit "Positive/Negative EOT Limit Encountered.")	Clear the appropriate Positive/Negative End-of-Travel Limit Encountered Bit. Clear any Master Kill All Motion Request Bit, and any Axis Kill All Motion Request Bits.
I/Os not working	Positive/Negative End-of-Travel (EOT) Limits not working. Check the wiring of the limits, referring to their respective hardware installation guides. Check if the Positive/Negative EOT Limits are enabled: Status Panels → Bit Status → Axis Flags → Quinary Axis Flags. (Each axis is indicated by Bit "Positive/Negative EOT Limit Enable.")	Check that the associated inputs toggled: <ul style="list-style-type: none"> <li>▶ If using onboard I/O: Status Panels → Bit Status → Onboard I/O and User Flags (0-3).</li> <li>▶ If using Expansion I/O: Status Panels → Bit Status → CANopen Flags (ACR9000).</li> </ul> NOTE: A triggered output will create a contact closure, not a voltage source.
I/O not working properly	Incorrect I/Os wiring.	Check wiring and external circuitry. Refer to <i>ACR9000 Hardware Installation Guide</i> .
Servo motor runs away;	Analog output / encoder multiplier mismatch. Verify analog output by Status Panels → Numeric Status → Object Parameters → DAC Parameters. Verify encoder input by Status Panels → Numeric Status → Object Parameters → Encoder Parameters.	If encoder feedback is correct for appropriate direction, change "DAC GAIN" to the opposite value. If encoder feedback is not correct for appropriate direction, change "ENC MULT" to the opposite value.
	Amplifier has an analog input offset.	Correct the analog offset in the amplifier.
	Electrical noise.	Reduce electrical noise or move the product away from the noise source.
	Improper shielding.	Use shielded, twisted pair wiring for encoder inputs, DAC/stepper outputs, and ADC inputs.
	Improper wiring.	Check wiring for shorts, opens, and mis-wired connections.

Table 1 Common Problems and Their Solutions

# Error Handling

---

This section on error handling addresses error checking and recovery, which is to be programmed into each application. Error handling is then done automatically as the application runs, and is helpful in diagnosing problems.

## *Sample Program (ACR90x0)*

The following is an example error handling routine for the ACR90x0 with firmware revision 1.18.15 and above. It was written to handle possible axis, CANopen, and Motion Enable Input error conditions.

Parker does not intend this to be an actual application solution. Use this program as an example for error handling, and tailor the routines for your specific needs.

This program is modular to illustrate the use of subroutines which decrease programming and debugging time.

Program Notes:

- ▶ This program checks for errors in program 0 (PROG0) and master 0. It does not attempt to recover from the fault; it only prints error messages to a terminal (using string variables).
- ▶ This code can be used in any unused program from PROG1 to PROG7.
- ▶ When an Axis Kill All Motion Request is set, this program clears related error conditions, such as Software and Hardware End-of-Travel (EOT) flags, because they are not self-clearing.
- ▶ Each application will have different requirements, and code should be created specifically for individual applications.

This example program uses four parameters for storing error codes (arbitrarily assigned to P50, P51, P52 and P53) that can be retrieved from an operator interface.

This error program can be started from the "main" or startup program using the **RUN** command, or by setting the appropriate Program Run Request flag (for example, Bit 1032 for program 0). It can also be started by putting **PBOOT** in the first line of the example program (remove **REM** from the line with PBOOT in it).

```
REM Generic Two-axis Error Checking and Recovery Routine for ACR9000
' *****DISCLAIMER*****
' While precautions have been taken in the preparation of this note,
' Parker and the author assume no responsibility for errors or
' omissions. Neither is any liability assumed for damages resulting
' from the use of the information contained herein.
```

' This software program is provided free of charge and without  
' warranty of any kind, either expressed or implied. In no event  
' will PARKER HANNIFIN CORPORATION be liable for any damages,  
' including but not restricted to lost profits, lost savings, or  
' component failure arising out of the use or inability to use this  
' software program. The sole purpose of this program is to  
' demonstrate the functional application of the customer's desired  
' application. It is the responsibility of the user to insure that  
' this program is not misused.

' \*\*\*\*\*

REM Assign user names (aliases) to system flags and parameters.  
REM Ensure a minimum memory allocation for 50 aliases when setting  
REM up project in ACR-View's Configuration Wizard. Program memory  
REM requirement should be at least 15000 bytes to store and run  
REM program.

#DEFINE XPosSoftEOT BIT16140  
#DEFINE XNegSoftEOT BIT16141  
#DEFINE YPosSoftEOT BIT16172  
#DEFINE YNegSoftEOT BIT16173

#DEFINE XPosHardEOT BIT16132  
#DEFINE XNegHardEOT BIT16133  
#DEFINE YPosHardEOT BIT16164  
#DEFINE YNegHardEOT BIT16165

#DEFINE XNotExcessError BIT769  
#DEFINE YNotExcessError BIT801

#DEFINE XDriveFault BIT8477  
#DEFINE YDriveFault BIT8509

#DEFINE HaltProgOnError BIT128  
#DEFINE PrintErrors BIT129  
#DEFINE ErrorOccurred BIT130  
#DEFINE ClearErrorCodes BIT131

#DEFINE KillMasterMoves BIT522  
#DEFINE XKillAllMotion BIT8467  
#DEFINE YKillAllMotion BIT8499  
#DEFINE XExcessErrorFault BIT8479  
#DEFINE YExcessErrorFault BIT8511  
#DEFINE XDriveEnabled BIT8465  
#DEFINE YDriveEnabled BIT8497

#DEFINE XEncoderFault BIT2560 : REM BIT 2560,2561 are for ENC0  
#DEFINE XEncoderLost BIT2561  
#DEFINE YEncoderFault BIT2592 : REM BIT 2592,2593 are for ENC1  
#DEFINE YEncoderLost BIT2593

#DEFINE MotionEnableOpen BIT5646  
#DEFINE LatchedMEIOpen BIT5645

```

REM error codes to retrieve via front end application
#DEFINE MEIErrorCode P50
#DEFINE CANopenErrorCode P51
#DEFINE XErrorCode P52
#DEFINE YErrorCode P53

REM additional variables used to determine when the error occurred
#DEFINE Time LV0
#DEFINE ms LV1
#DEFINE seconds LV2
#DEFINE ExcSeconds LV3
#DEFINE minutes LV4
#DEFINE ExcMinutes LV5
#DEFINE hours LV6
#DEFINE ExcHours LV7
#DEFINE days LV8

PROGRAM
PBOOT : REM program will execute when controller power is turned on

REM dimension some string variables for error message
REM storage/display and integers for clock
DIM $V(10,80)
DIM LV10

REM initialize error codes to zero
MEIErrorCode = 0
CANopenErrorCode = 0
XErrorCode = 0
YErrorCode = 0

REM clear "PrintErrors" to prevent forced printing of error messages
SET PrintErrors

REM clear "ClearErrorCodes" to prevent this program from clearing
REM codes after printing
SET ClearErrorCodes

_LoopStart
REM --- Print out errors to a terminal if "PrintErrors" bit is set
IF (PrintErrors)
    'OPEN "COM1:38400,n,8,1" AS # 1
    'OPEN "STREAM1:" AS #1 : REM for USB
    'OPEN "STREAM2:" AS #1 : REM for Enet, 1st connection
    OPEN "STREAM3:" AS #1 : REM for Enet, 2nd connection
    ELSE
    CLOSE #1
    ENDIF

REM ----- Check Motion Enable Input -----
IF (MotionEnableOpen AND MEIErrorCode = 0)
    SET ErrorOccurred
    MEIErrorCode = 1
    $V0 = "Motion Enable Input is open"
    ELSE IF (NOT MotionEnableOpen and MEIErrorCode = 1)
    MEIErrorCode = 0

```



```

SET 5647 : REM request reset of the MEI input latched status
           REM flag (bit 5645)
INH -5647 : REM wait until request has finished
           REM Clear axis KAMR flags
CLR XKillAllMotion
CLR YKillAllMotion
$V0 = "Motion Enable Input is good"
ENDIF

```

```

REM - Check CANopen (PIO) status (only needed if using CANopen I/O)
IF (P32779 > 0)
  IF (P32779 = 2)
    $V1 = "CANopen status is good"
    CANopenErrorCode = 0
  ELSE IF (P32779 = 1)
    $V1 = "CANopen is ready to start (SET 11265)"
    CANopenErrorCode = 0
  ELSE IF (P32779 > 2 AND CANopenErrorCode = 0)
    REM prevents recursive error display
    CANopenErrorCode = P32779
    SET ErrorOccurred
    $V1 = "CANopen network problem occurred."
  ENDIF
ENDIF
ENDIF

```

```

REM ----- SOFTWARE EOT's -----
REM Software End-of-Travels (EOT's) do not set the axis
REM Kill All Motion Request (KAMR) flags so must be
REM handled separately.

```

```

REM ----- X Software EOT's -----
IF (XPosSoftEOT AND XErrorCode <> 1)
  INH -792
  Set ErrorOccurred
  XErrorCode = 1
  $V2 = "Positive Software End-of-travel hit, Axis 0"
  CLR XPosSoftEOT : REM EOT flag is automatically cleared,
                   REM but we clear it to prevent recursive
                   REM printing of error

  INH -XPosSoftEOT
  CLR KillMasterMoves
ENDIF

```

```

IF (XNegSoftEOT AND XErrorCode <> 2)
  INH -792
  Set ErrorOccurred
  XErrorCode = 2
  $V2 = "Negative Software End-of-travel hit, Axis 0"
  CLR XNegSoftEOT : REM EOT flag is automatically cleared,
                   REM but we clear it to prevent recursive
                   REM printing of error

  INH -XNegSoftEOT
  CLR KillMasterMoves
ENDIF

```

```

REM ----- Y Software EOT's -----
IF (YPosSoftEOT AND YErrorCode <> 1)
  INH -824
  Set ErrorOccurred
  YErrorCode = 1
  $V3 = "Positive Software End-of-travel hit, Axis 1"
  CLR YPosSoftEOT : REM EOT flag is automatically cleared,
                  REM but we clear it to prevent recursive
                  REM printing of error
  INH -YPosSoftEOT
  CLR KillMasterMoves
ENDIF

IF (YNegSoftEOT AND YErrorCode <> 2)
  INH -824
  Set ErrorOccurred
  YErrorCode = 2
  $V3 = "Negative Software End-of-travel hit, Axis 1"
  CLR YNegSoftEOT : REM EOT flag is automatically cleared,
                  REM but we clear it to prevent recursive
                  REM printing of error

  INH -YNegSoftEOT
  CLR KillMasterMoves
ENDIF

REM ----- Check Axis X -----
IF (XKillAllMotion AND NOT LatchedMEIOpen)
  INH -792 : REM When KAMR flag is set, all motion stops with
          REM JOG move
  SET ErrorOccurred
  XErrorCode = 0 : REM Error number for axis 0
  REM some "master" programs can be resumed, all others must be
  REM halted when error occurs.

  IF (HaltProgOnError)
    HALT PROG0 : REM stop program 0 and kill interpolated motion
              REM (MOV, CIRCW, CIRCCW, SINE)
  ELSE
    PAUSE PROG0 : REM issue RESUME PROG0 or CLR1048 to
              REM resume main prog
  ENDIF
ENDIF

REM ----- Hardware EOT's -----
IF (XPosHardEOT)
  XErrorCode = 3
  $V2 = "Positive Hardware End-of-travel hit, Axis 0"
  CLR XPosHardEOT : REM EOT flag is not automatically
                  REM cleared, program must clear it
ENDIF

IF (XNegHardEOT)
  XErrorCode = 4
  $V2 = "Negative Hardware End-of-travel hit, Axis 0"
  CLR XNegHardEOT : REM EOT flag is not automatically
                  REM cleared, program must clear it
ENDIF

```

```

REM ----- Excess position error -----
IF (XExcessErrorFault)
  XErrorCode = 5
  $V2 = "Axis 0 disabled due to excess position error"
  CLR XExcessErrorFault
ENDIF

REM -- Use only for servo axes !!! Encoder Signal Lost or Fault
IF (NOT XDriveEnabled AND (XErrorCode = 0) AND (XEncoderFault OR
XEncoderLost))
  XErrorCode = 6
  $V2 = "Axis 0 disabled due to encoder fault"
  ENC 0 RES : REM try to reset encoder
ENDIF

REM if none of the errors above, then possible Drive Fault
REM Input caused error.
IF (XErrorCode = 0)
  $V2 = ""
  REM Drive Fault
  IF (XDriveFault)
    $V2 = $V2 + "Latched Drive Fault, Axis 0."
  ELSE
    $V2 = "Other fault (user set KAMR bit, EPL Network Fault, etc.)"
  ENDIF
  XErrorCode = 7 : REM no separate code for drive fault
ENDIF

REM ----- Clear KILL bits -----
CLR XKillAllMotion : REM BIT8467
CLR KillMasterMoves : REM BIT522

ENDIF : REM end of Axis X checking

IF (XErrorCode = 0)
  $V2 = "No errors on axis 0"
  REM XErrorCode should be cleared/acknowledged by HMI/operator
  REM interface
ENDIF

REM ----- Check Axis Y -----
IF (YKillAllMotion AND NOT LatchedMEIOpen)
  INH -824 : REM When KAMR flag is set, all motion stops with
    REM JOG move
  SET ErrorOccurred
  YErrorCode = 0 : REM Error number for Axis 1
  REM some "master" programs can be resumed, all others must be
  REM halted when error occurs.
  IF (HaltProgOnError)
    HALT PROG0
  ELSE
    PAUSE PROG0 : REM issue RESUME PROG0 to continue
  ENDIF

```

```

REM ----- Hardware EOT's -----
IF (YPosHardEOT)
  YErrorCode = 3
  $V3 = "Positive Hardware End-of-travel hit, Axis 1"
  CLR YPosHardEOT : REM EOT flag is not automatically
                   REM cleared, program must clear it
ENDIF
IF (YNegHardEOT)
  YErrorCode = 4
  $V3 = "Negative Hardware End-of-travel hit, Axis 1"
  CLR YNegHardEOT : REM EOT flag is not automatically
                   REM cleared, program must clear it
ENDIF

REM ----- Excess position error -----
IF (YExcessErrorFault)
  YErrorCode = 5
  $V3 = "Axis 1 disabled due to excess position error"
  CLR YExcessErrorFault
ENDIF

REM -- Use only for servo axes !!! Encoder Signal Lost or Fault
IF (NOT YDriveEnabled AND (YErrorCode = 0) AND (YEncoderFault OR
YEncoderLost))
  YErrorCode = 6
  $V3 = "Axis 1 disabled due to encoder fault"
  ENC 1 RES : REM try to reset encoder
ENDIF

REM if none of the errors above, then possible Drive Fault Input
REM caused error.
IF (YErrorCode = 0)
  $V3 = ""
  REM Drive Fault
  IF (YDriveFault)
    $V3 = $V3 + "Latched Drive Fault, Axis 1."
  ELSE
    $V3 = "Other fault (user set KAMR bit, EPL Network Fault, etc.)"
  ENDIF
  YErrorCode = 7 : REM no separate code for drive fault vs.
ENDIF

REM ----- Clear KILL bits -----
CLR YKillAllMotion : REM BIT8499
CLR KillMasterMoves : REM BIT522

ENDIF : REM end of Axis Y checking

IF (YErrorCode = 0)
  $V3 = "No errors on Axis 1"
  REM YErrorCode should be cleared/acknowledged by HMI/front end
  REM application
ENDIF

```

```

REM ----- Print error out comm1 to terminal -----
IF (ErrorOccurred)
  REM Print time since controller power on or reset
  GOSUB CheckTime

  IF (MEIErrorCode > 0)
    PRINT #1, "MEI Error ";MEIErrorCode;" -> " ;$V0
    REM Motion Enable Input status
  ENDIF
  IF (CANopenErrorCode > 0)
    PRINT #1, "CANopen Error ";CANopenErrorCode;" -> " ;$V1
    REM CANopen status
  ENDIF
  IF (XErrorCode > 0)
    PRINT #1, "Axis 0 Error ";XErrorCode;" -> " ;$V2 : REM Axis 0
    REM status
  ENDIF
  IF (YErrorCode > 0)
    PRINT #1, "Axis 1 Error ";YErrorCode;" -> " ;$V3 : REM Axis 1
    REM status
  ENDIF
  PRINT #1, "" : REM print a blank line between error messages

  REM error codes must be cleared by HMI or by this program
  IF (ClearErrorCodes) : REM set Axis ClearErrorCodes to have
    REM program clear codes automatically
    XErrorCode = 0
    YErrorCode = 0
  ENDIF
  CLR ErrorOccurred
ENDIF

GOTO LoopStart

_CheckTime
REM This implements a "clock" for showing time since power up or
REM reboot, assuming P6916 is not set by user. P6916 resets to zero
REM at 2**31 (2^31). P6916 is a free-running clock in milliseconds

Time = P6916 : REM capture current time in ms.

REM extract the millisecond portion
ms = Time MOD 1000 : REM extract any ms less than 1 full second

REM extract the second portion
REM remove ms from the Time and convert time to seconds
seconds = (Time - ms)/1000

ExcSeconds = seconds MOD 60 : REM extract any seconds less than a
REM full minute

REM extract the minute portion
REM remove seconds from the Time and convert time to minutes
minutes = (seconds - ExcSeconds) / 60

REM extract any minutes less than a full hour

```

```
ExcMinutes = minutes MOD 60

REM extract the hour portion
REM remove excess minutes and convert to full hours
hours = (minutes - ExcMinutes) /60

REM remove any hours less than a full day
ExcHours = hours mod 24

REM only full days are left. Only works up to <25 days.
REM remove excess hours and convert what's left to days
days = (hours - ExcHours)/24

PRINT #1, "Approximate Time Running : ";days;" Days ";
PRINT #1, USING "##";ExcHours;" Hours ";
PRINT #1, USING "##";ExcMinutes;" Minutes ";
PRINT #1, USING "##";ExcSeconds;".";"ms;" Seconds "
RETURN

ENDP
```

# Appendix

---

The appendix contains supplemental materials not directly related to any specific ACR series controller discussion.

## IP Addresses, Subnets, & Subnet Masks

The factory assigns an IP address of 192.168.10.40 and a subnet mask of 255.255.255.0 to each controller. Before adding the controller to your network, assign it an IP address and subnet mask appropriate for your network.



**Caution** —Talk with your Network Administrators before assigning an IP address or subnet mask to a controller. They can provide you with an available IP address, as well as which subnet mask is appropriate for your particular network configuration.

Isolate the ACR9000 controller and related devices on their own subnet. The high-volume traffic on networks can affect the ACR9000 controller's performance. A closed network restricts the flow of traffic to only the controller and related devices.

The IP address and subnet mask you assign each controller determines to which subnet each controller belongs. To manage the flow of data across a network, it can be divided into subnets smaller networks within a network to provide more efficient delivery of data.

### IP Addresses

An IP address is an identifier for a device on a TCP/IP network. Every device connected to the Internet must use a unique IP Address.

The IP address is comprised of a 32-bit binary address that is subdivided into four 8-bit segments known as octets. Because people do not generally think in binary, the address is expressed in dotted decimal format. Each binary octet is converted to a decimal number ranging from 0 to 255, with each octet separated by a decimal point. For example, an IP address in dotted decimal format looks like the following:

*192.168.10.120*

The address consists of a network ID and a host ID. The network ID acts as a general address, like a zip code; The host ID is the address for a specific device within the network, like a home address. Most IP addresses fall into one of the following address classes:

- Class A range. The first 8 bits are for the network ID; The remaining 24 bits are for the host ID.
- Class B range. The first 16 bits are for the network ID; The remaining 16 bits are for the host ID.
- Class C range. The first 24 bits are for the network ID; The remaining 8 bits are for the host ID.

The number of bits used for the network ID determine how many hosts a given address can support. Class A networks provide a small number of network IDs but a very large number of host IDs. And class C networks provide a huge number of network IDs but a small number of host IDs.

Before a computer or router can send data, it has to identify the network ID through the address class. Each class is assigned a range of numbers.

Address Class	First octet in dotted decimal format begins with	Excluded from Internet, Allowed for Intranet
A	0 to 127	10.0.0.0 to 10.255.255.255 127.0.0.0 to 127.255.255.255
B	128 to 191	172.16.0.0 to 172.31.255.255
C	192 to 223	192.168.0.0 to 192.168.255.255

Certain IP addresses have particular meanings and are not assigned to host devices.

- Using zeroes as a host ID signifies the entire network. For example, the IP address of 192.168.0.0 indicates network 192.168 where specific hosts can be found.
- Using 255 in an octet indicates a broadcast, where data is sent to all host devices on a network. For example, the IP Address 192.168.255.255 will broadcast data to all host devices in that network.



Suppose you have 6 computers in a class C network. All share the same network address 192.168.10. in the first three octets. The final octet for each computer is different, and represents the host ID.

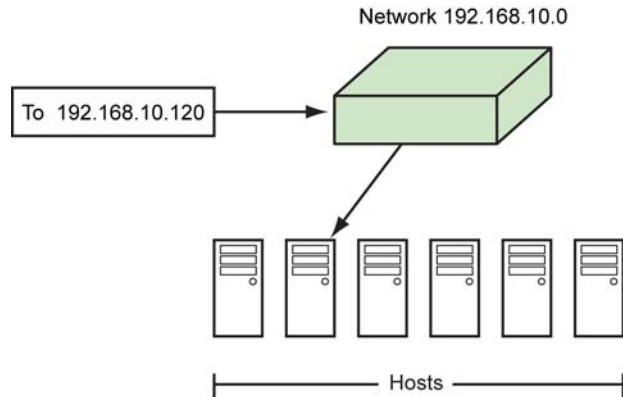

Some addresses are reserved for private networks or intranets, where networks are masked or protected from the Internet:

10.0.0.0 to 10.255.255.255

172.16.0.0 to 172.31.255.255

192.168.0.0 to 192.168.255.255

For additional information on private IP addresses, refer to IEEE specification RFC 1918 Address Allocation for Private Internets. You can view it at <http://www.faqs.org/rfcs/rfc1918.html>

## *Subnets*

As networks increase in size, it becomes more complex to deliver information. Subnets provide a logical way to break apart network addresses into smaller, more manageable groups. There are additional benefits including more efficient communications between devices, and increases to the overall network capacity.

### **Subnet IDs**

When sending data from one host to another, routers use the network ID (see above) in the IP address to locate the network. On finding the network, the network is searched for the specific host. With a great deal of network traffic this proves cumbersome. Under these circumstances, an IP address does not provide enough information for routers and host devices to efficiently locate a host device.

To provide another level of addressing, some of the host ID is borrowed to create a subnet ID. The subnet ID allows you to logically group devices together (often related to a specific network segment). Once data arrives at the network, the subnet ID allows routers or host devices to locate the appropriate network segment, and then the host.

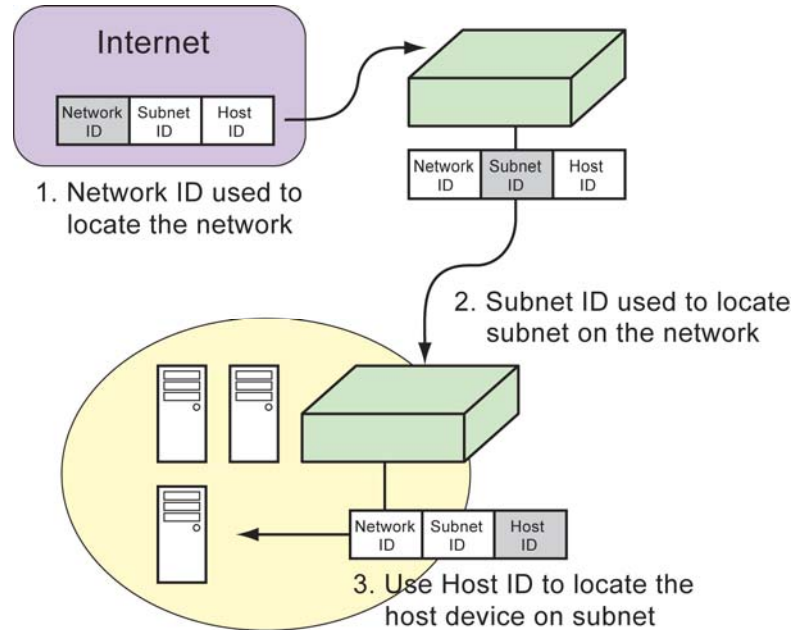

Suppose you have a class C network, comprised of 6 computers. All share the same network ID 192.168. but are divided into two subnets. Three computers use 192.168.10., where 10. is the subnet ID; the remaining three use 192.168.5., where 5. is the subnet ID.

## Subnet Masks

A subnet mask determines how many bits after the network ID are used for the subnet ID. As the subnet ID increases, the number of host IDs available for that network decrease. Similarly, a smaller subnet ID allows you to increase the number of hosts on the network. For simplicity, this discussion only looks at complete octets in dotted decimal format, and does not explore converting partial masks from binary to decimal.

What subnet mask to use depends on your network configuration, and address class. Where the host ID appears in the IP address, use a zero in the subnet mask. And where the network ID and subnet ID appear, use 255 in the subnet mask. Suppose on network 172.20.0.0 (class B) you have to set up a new computer. You assign it 172.20.44.180 as the IP address. As a class B network, the first two octets are reserved for the network ID. The third octet is reserved for the subnet ID, and the last octet is for the host ID. So using the subnet mask 255.255.255.0 identifies the final octet as the host ID.

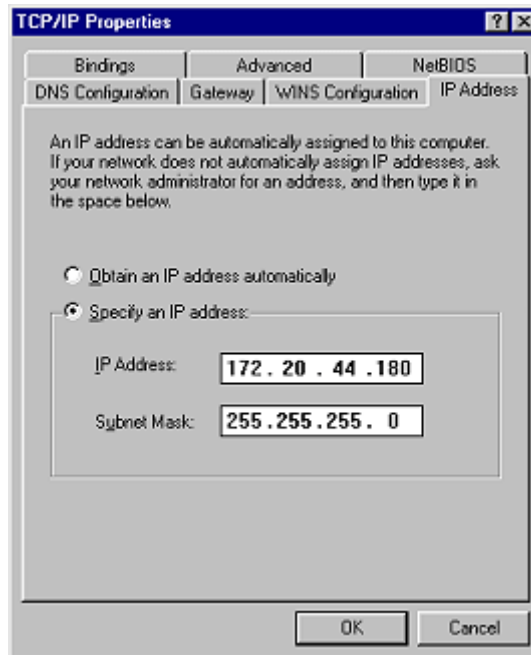

## Output Module Software Configuration Examples

The following commands are used to configure the ACR1200, ACR1500, ACR2000, ACR8000, ACR8010 output modules for operation:

- ▶ **CONFIG** tells the control what type of output module is installed.
- ▶ **ATTACH AXIS** attaches the axis to signal output and feedback.
- ▶ **ESAVE** saves the axis attachments.

### Example 1

The following example configures an eight axis ACR8000/ACR8010 board for eight axis of open-loop steppers (two stepper output modules); also included on the board is an analog input module (ADC input module):

```
CONFIG NONE STEPPER4 STEPPER4 NONE
ATTACH AXIS0 STEPPER0 STEPPER0
ATTACH AXIS1 STEPPER1 STEPPER1
ATTACH AXIS2 STEPPER2 STEPPER2
ATTACH AXIS3 STEPPER3 STEPPER3
ATTACH AXIS4 STEPPER4 STEPPER4
ATTACH AXIS5 STEPPER5 STEPPER5
ATTACH AXIS6 STEPPER6 STEPPER6
ATTACH AXIS7 STEPPER7 STEPPER7
ESAVE
```

### Example 2

The following example configures an eight axis ACR8000/ACR8010 board for four closed-loop servos and four open-loop steppers (one DAC output module and one stepper output module):

```
CONFIG ENC4 DAC4 STEPPER4 NONE
ATTACH AXIS0 ENC0 DAC0
ATTACH AXIS1 ENC1 DAC1
ATTACH AXIS2 ENC2 DAC2
ATTACH AXIS3 ENC3 DAC3
ATTACH AXIS4 STEPPER4 STEPPER4
ATTACH AXIS5 STEPPER5 STEPPER5
ATTACH AXIS6 STEPPER6 STEPPER6
ATTACH AXIS7 STEPPER7 STEPPER7
```

### Example 3

The following example configures an eight axis ACR8010 board for two closed-loop servos with two commutator and two open-loop steppers (one DAC output module and one stepper output module):

```
CONFIG ENC4 DAC4 STEPPER4 NONE
ATTACH AXIS0 ENC0 CMT0 ENC0
ATTACH AXIS1 ENC2 CMT1 ENC2
ATTACH AXIS4 STEPPER4 STEPPER4
ATTACH AXIS5 STEPPER5 STEPPER5
ATTACH AXIS6 STEPPER6 STEPPER6
```

```
ATTACH AXIS7 STEPPER7 STEPPER7
AXIS2 OFF
AXIS3 OFF
CMT0 ENC0 ENC1
CMT0 DAC0 DAC1
CMT1 ENC2 ENC3
CMT1 DAC2 DAC3
```

### Example 4

The following example configures a four axis ACR1500 with four on-board stepper outputs or a four axis ACR2000 with one stepper output module for four open-loop steppers. Also included on the board is an analog input module (ADC input module).

**NOTE:** On the ACR1500 and ACR2000 card, the attach axis statements for AXIS4 through AXIS7 must be left in the default configuration to ensure proper operation.

```
CONFIG NONE STEPPER4 NONE ADC8
ATTACH AXIS0 STEPPER0 STEPPER0
ATTACH AXIS1 STEPPER1 STEPPER1
ATTACH AXIS2 STEPPER2 STEPPER2
ATTACH AXIS3 STEPPER3 STEPPER3
ESAVE
```

### Example 5

The following example configures a two axis ACR1200 with two on-board stepper outputs or a four axis ACR2000 with one stepper output module for four open-loop steppers. Also included on the board is an analog input module (ADC input module).

**NOTE:** On the ACR1500 and ACR2000 card, the attach axis statements for AXIS4 through AXIS7 must be left in the default configuration to ensure proper operation.

```
CONFIG NONE STEPPER4 NONE ADC8
ATTACH AXIS0 STEPPER0 STEPPER0
ATTACH AXIS1 STEPPER1 STEPPER1
ATTACH AXIS2 STEPPER2 STEPPER2
ATTACH AXIS3 STEPPER3 STEPPER3
ESAVE
```

### Example 6

The following example configures a four axis ACR1500 with two on-board DAC outputs for two closed loop servos. Also included on the board is an analog input module (ADC input module).

**NOTE:** On the ACR1200 card, the attach axis statements for AXIS3 through AXIS7 must be left in the default configuration to ensure proper operation.

```
CONFIG ENC3 DAC2 NONE ADC8
ATTACH AXIS0 ENC0 DAC0
ATTACH AXIS1 ENC1 DAC1
ESAVE
```

### Example 7

The following example configures a 2 axis ACR1200 with one on-board DAC output and one on-board stepper output for one closed loop servo and one open-loop stepper. Also included on the board is an analog input module (ADC input module).

**NOTE:** On the ACR1200 card, the attach axis statements for AXIS2 through AXIS7 must be left in the default configuration to ensure proper operation.

```
CONFIG ENC3 DACSTEP2 NONE ADC8
ATTACH AXIS0 ENCO DAC0
ATTACH AXIS1 STEPPER0 STEPPER0
ESAVE
```

# Index

AcroBASIC		Drive Talk	
commands .....	12	auto-address .....	142
syntax .....	8	bits .....	141
aliases		configuration flags .....	142
bits .....	7, 26	drive status flags .....	143
constants .....	7	error flags .....	143
DEFINE .....	7	parameters .....	141
parameters .....	7, 26	pass through mode .....	145
variables .....	7	RS-232 .....	141
bits		RS-485 .....	141
aliases .....	26	starting .....	144
clearing .....	26	stopping .....	144
overview .....	24	EPL network .....	92
printing .....	26	errors	
setting .....	25	documenting .....	149
using .....	25	error handling .....	158
branching		sample program .....	158
repetition .....	22	factory default .....	40
selection .....	19	feedback	
CANopen		control .....	59
AcroBASIC .....	131	formulas .....	27
analog		homing	
inputs .....	137	backup enable .....	79, 81, 83
outputs .....	137	bits .....	79
bit		commands .....	79
rate .....	128	dedicated I/O .....	85
resolution .....	137	direction .....	77
bus states .....	135	example code .....	78, 93
health period .....	130	final direction .....	79, 83
heart beating protocol .....	130	jogging .....	77
information parameters .....	131	limit deceleration .....	85
LED status .....	134	limit detection .....	85
mapping digital I/O .....	127	limit range .....	85
network configuration .....	128	negative edge selection .....	79, 83
node		overview .....	77
address .....	128	subroutine .....	79
availability .....	127	LED	
guarding protocol .....	130	troubleshooting .....	150, 151, 152
ID136		limits	
speed .....	129	homing .....	77
parameters		linear interpolation	
extended I/O .....	137	coordinated moves profiler .....	63
saving .....	139	mathematical operations .....	27
start network .....	130	memory allocation .....	39
transmission cycle .....	129	motion	
change summary .....	5	absolute .....	49
commands		cam profiler .....	48, 77
format .....	9	commanding .....	49, 58
immediate mode .....	12	comparison .....	50
syntax .....	8, 10	coordinated moves profiler .....	48, 63
communication		feedback control .....	59
troubleshooting .....	152, 153	gear profiler .....	48, 76
configuration		immediate .....	52
example .....	41	incremental .....	50
firmware revision .....	45	jog profiler .....	48
global variables .....	46	profiler interaction .....	54
reserved resources .....	45	profiles .....	53
user groups .....	47	servo loop status .....	88
cycling power .....	39	velocity profiles .....	53, 58
dedicated I/O			
homing .....	85		

parameters			
aliases .....	26	running .....	13
overview .....	24	starting .....	13
using .....	25	starting, automatically .....	13
parametric evaluation .....	27	start-up .....	39
PBOOT command .....	39	program flow	
problems .....	149	pause .....	24
program		repetition .....	22
adding code on-the-fly .....	12	selection .....	19
branching		rebooting controller .....	39
repetition .....	22	REM statement .....	<i>See</i> remarks
selection .....	19	remarks	
halting .....	13	format .....	8
labels .....	7	RFS .....	<i>See</i> factory default
listening .....	13	start-up program .....	39
pausing .....	14	teach array .....	97
resuming .....	14	technical support .....	ii
		troubleshooting .....	149, 150